

Inleiding Topologie 2011/2012
Lecturer: Marius Crainic

Contents

Chapter 1. Introduction: some standard spaces	5
1. Keywords for this course	5
2. Spaces	7
3. The circle	9
4. The sphere and its higher dimensional versions	12
5. The Moebius band	15
6. The torus	17
7. The Klein bottle	20
8. The projective plane \mathbb{P}^2	22
9. Gluing (or quotients)	24
10. Metric aspects versus topological ones	27
Chapter 2. Topological spaces	29
1. Topological spaces	30
2. Continuous functions; homeomorphisms	32
3. Neighborhoods and convergent sequences	34
4. Inside a topological space: closure, interior and boundary	36
5. Hausdorffness; 2nd countability; topological manifolds	38
6. More on separation	40
7. More exercises	41
Chapter 3. Constructions of topological spaces	47
1. Constructions of topologies: quotients	48
2. Examples of quotients: the abstract torus, Moebius band, etc	49
3. Special classes of quotients I: quotients modulo group actions	50
4. Another example of quotients: the projective space \mathbb{P}^n	51
5. Constructions of topologies: products	53
6. Special classes of quotients II: collapsing a subspace, cones, suspensions	55
7. Constructions of topologies: Bases for topologies	57
8. Constructions of topologies: Generating topologies	58
9. Example: some spaces of functions	59
10. More exercises	61
Chapter 4. Topological properties	65
1. Connectedness	66
2. Compactness	70
3. Local compactness and the one-point compactification	77
4. More exercises	80
Chapter 5. Partitions of unity	85
1. Some axioms for sets of functions	86
2. Finite partitions of unity	87

3. Arbitrary partitions of unity	88
4. The locally compact case	90
5. Urysohn's lemma	91
6. More exercises	93
Chapter 6. Metric properties versus topological ones	95
1. Completeness and the Baire property	96
2. Boundedness and totally boundedness	97
3. Compactness	98
4. Paracompactness	100
5. More exercises	101
Chapter 7. Metrization theorems	103
1. The Urysohn metrization theorem	104
2. The Smirnov Metrization Theorem	105
3. Consequences: the compact case, the locally compact case, manifolds	106
Chapter 8. Spaces of functions	107
1. The algebra $\mathcal{C}(X)$ of continuous functions	108
2. Approximations in $\mathcal{C}(X)$: the Stone-Weierstrass theorem	110
3. Recovering X from $\mathcal{C}(X)$: the Gelfand Naimark theorem	112
4. General function spaces $\mathcal{C}(X, Y)$	114
5. More exercises	119
Chapter 9. Embedding theorems	121
1. Using function spaces	122
2. Using covers and partitions of unity	123
3. Dimension and open covers	125

Introduction: some standard spaces

1. Keywords for this course

In this course we study topological spaces. One may remember that in group theory one studies groups- and a group is a set G together with some extra-structure (the group operation) which allows us to multiply the elements of G . Similarly, a topological space is a set X together with some “extra-structure” which allows us to make sense of “two points getting close to each other” or, even better, it allows us to make sense of statements like: a sequence $(x_n)_{n \geq 1}$ of elements of X converges to $x \in X$. Of course, if X is endowed with a “metric” (i.e. a way to measure, or to give sense to, “the distance between two points of X ”), then such statements have a clear intuitive meaning and can easily be made precise. However, the correct extra-structure that is needed is a bit more subtle- it is the notion of topology on X which will be explained in the next chapter.

The interesting functions in topology are the continuous functions. One may remember that, in group theory, the interesting functions between two groups G_1 and G_2 are not all arbitrary functions $f : G_1 \rightarrow G_2$, but just those which “respect the group structure” (group homomorphisms). Similarly, in topology, the interesting maps between two topological spaces X and Y are those functions $f : X \rightarrow Y$ which are continuous. Continuous means that “it respects the topological structures”- and this will be made precise later. But roughly speaking, f being continuous means that it maps convergent sequences to convergent sequences: if $(x_n)_{n \geq 1}$ is a sequence in X converging to $x \in X$, then the sequence $(f(x_n))_{n \geq 1}$ of elements of Y converges to $f(x) \in Y$.

The correct notion of isomorphism in topology is that of homeomorphism. In particular, we do not really distinguish between spaces which are homeomorphic. Thinking again back at group theory, there we do not really distinguish between groups which are isomorphic- and there the notion of isomorphism was: a bijection which preserves the group structure. Similarly, in topology, a homeomorphism between two topological spaces X and Y is a bijection $f : X \rightarrow Y$ so that f and f^{-1} are both continuous (note the apparent difference with group theory: there, a group isomorphism was a bijection $f : G_1 \rightarrow G_2$ such that f is a group homomorphism. The reason that, in group theory, we do not require that f^{-1} is itself a group homomorphism, is simple: it follows from the rest!).

Some of the main questions in topology are:

1. how to decide whether two spaces are homeomorphic (= the same topologically) or not?
2. how to decide whether a space is metrizable (i.e. the topology comes from a metric)?
3. when can a space be embedded (“pictured”) in the plane, in the space, or in a higher \mathbb{R}^n ?

These questions played the role of a driving force in Topology. Most of what we do in this course is motivated by these questions; in particular, we will see several results that give answers to them. There are several ways to tackle these questions. The first one - and this will keep us busy for a while- is that of finding special properties of topological spaces, called

topological properties (such as Hausdorffness, connectedness, compactness, etc). For instance, a space which is compact (or connected, or etc) can never be homeomorphic to one which is not. Another way is that of associating topological invariants to topological spaces, so that, if two spaces have distinct topological invariant, they cannot be homeomorphic. The topological invariants could be numbers (such as “the number of distinct connected components”, or “the number of wholes”, or “the Euler characteristic”), but they can also be more complicated algebraic objects such as groups. The study of such topological invariants is another field on its own (and is part of the course “Topologie en Meetkunde”); what we will do here is to indicate from time to time the existence of such invariants.

In this course we will also devote quite some time to topological constructions i.e. methods that allow us to construct new topological spaces out of ones that we already know (such as taking the product of two topological spaces, the cone of a space, quotients).

Finally, I would like to mention that these lecture notes are based on the book “Topology” by James Munkres. But please be aware that the lecture notes should be self contained (however, you can have a look at the book if you want to find out more). The reason for writing lecture notes is that the book itself requires a larger number of lectures in order to achieve some of the main theorems of topology. In particular, in this lecture notes we present more direct approaches/proofs to such theorems. Sometimes, the price to pay is that the theorem we prove are not in full generality. Our principle is that: choose the version of the theorem that is most interesting for examples (as opposed to “most general”) and then find the shortest proof.

2. Spaces

In this chapter we present several examples of “topological spaces” before introducing the formal definition of “topological space” (but trying to point out the need for one). Hence please be aware: some of the statements made in this chapter are rather loose (un-precise)- and I try to make that clear by using quotes; the spaces that we mention here are rather explicit and intuitive, and when saying “space” (as opposed to “set”), we have in mind the underlying set (of elements, also called points) as well as the fact that we can talk (at least intuitively) about its points “getting closer to each other ” (or, even better, about convergence of sequences of points in the set). For those who insist of being precise, let us mention that, in this chapter, all our spaces are metric spaces (so that convergence has a precise meaning); even better, although in some examples this is not entirely obvious, all the examples from this chapter are just subspaces of some Euclidean space \mathbb{R}^n . Recall here:

DEFINITION 1.1. *Let X be a set. A metric on X is a function*

$$d : X \times X \rightarrow \mathbb{R}$$

which associates to a pair (x, y) of points x and y of X , a real number $d(x, y)$, called the distance between x and y , such that the following conditions hold:

(M1) $d(x, y) \geq 0$ for all $x, y \in X$.

(M2) $d(x, y) = 0$ if and only if $x = y$.

(M3) $d(x, y) = d(y, x)$.

(M4) (*triangle inequality*) $d(x, y) + d(y, z) \geq d(x, z)$ for all $x, y, z \in X$.

A metric space is a pair (X, d) consisting of a set X together with a metric d .

Metric spaces are particular cases of “topological spaces”- since they allow us to talk about convergence and continuity. More precisely, given a metric space (X, d) , and a sequence $(x_n)_{n \geq 1}$ of points of X , we say that $(x_n)_{n \geq 1}$ converges to $x \in X$ (in (X, d) , or with respect to d) if $\lim_{n \rightarrow \infty} d(x_n, x) = 0$. When there is no danger of confusion (i.e. most of the times), we will just say that X is a metric space without specifying d . Given two metric spaces X and Y , a function $f : X \rightarrow Y$ is called continuous if for any convergent sequence $(x_n)_{n \geq 1}$ in X , converging to some $x \in X$, the sequence $(f(x_n))_{n \geq 1}$ converges (in Y) to $f(x)$. A continuous map f is called a homeomorphism if it is bijective and its inverse f^{-1} is continuous as well. Two spaces are called homeomorphic if there exists a homeomorphism between them.

The most intuitive examples of spaces are the real line \mathbb{R} , the plane \mathbb{R}^2 , the space \mathbb{R}^3 or, more generally, the Euclidean space

$$\mathbb{R}^k = \{(x^1, \dots, x^k) : x^1, \dots, x^k \in \mathbb{R}\}$$

defined for any integer $k \geq 1$. For them we use the Euclidean metric and the notion of convergence and continuity with respect to this metric:

$$d(x, y) = \sqrt{(x^1 - y^1)^2 + \dots + (x^k - y^k)^2}$$

(for $x = (x^1, \dots, x^k)$, $y = (y^1, \dots, y^k) \in \mathbb{R}^k$). Another interesting metric on \mathbb{R}^k is the square metric ρ , defined by:

$$\rho(x, y) = \max\{|x_1 - y_1|, \dots, |x_n - y_n|\}.$$

The next exercise exercise shows that, although the notion of metric allows us to talk about convergence, metrics do not encode convergence faithfully (two very different looking metrics can induce the same convergent sequences, hence the same “space”). The key of understanding the “topological content” of metrics (i.e. the one that allows us to talk about convergent sequences) is the notion of open subsets- to which we will come back later.

EXERCISE 1.1. *Show that a sequence of points of \mathbb{R}^n is convergent with respect to the Euclidean metric if and only if it is convergent with respect to the square metric.*

Inside these Euclidean spaces sit other interesting topological spaces such as intervals, circles, spheres, etc. In general, any subset

$$X \subset \mathbb{R}^k$$

can naturally be viewed as a “space” (and as metric spaces with the Euclidean metric).

EXERCISE 1.2. *Show that, for any two numbers $a < b$*

1. *the interval $[a, b]$ is homeomorphic to $[0, 1]$.*
2. *the interval $[a, b)$ is homeomorphic to $[0, 1)$ and also to $[0, \infty)$.*
3. *the interval (a, b) is homeomorphic to $(0, 1)$ and also to $(0, \infty)$ and to \mathbb{R} .*

EXERCISE 1.3. *Explain why the three subset of the plane drawn in Figure 1 are homeomorphic.*

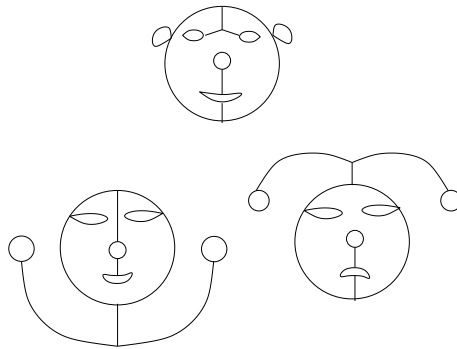

FIGURE 1.

EXERCISE 1.4. *Which of the subset of the plane drawn in Figure 2 do you think are homeomorphic? (be aware that, at this point, we do not have the tools to prove which two are not!).*

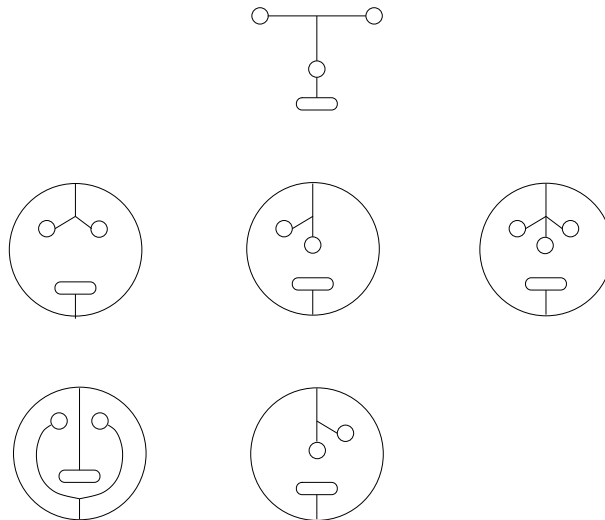

FIGURE 2.

3. The circle

In \mathbb{R}^2 one has the unit circle

$$S^1 = \{(x, y) \in \mathbb{R}^2 : x^2 + y^2 = 1\},$$

the open disk

$$\overset{\circ}{D} = \{(x, y) \in \mathbb{R}^2 : x^2 + y^2 < 1\},$$

the closed disk

$$D^2 = \{(x, y) \in \mathbb{R}^2 : x^2 + y^2 \leq 1\}.$$

Next, we mention the standard parametrization of the unit circle: any point on the circle can be written as

$$e^{it} := (\cos(t), \sin(t))$$

for some $t \in \mathbb{R}$. This gives rise to a function

$$e : \mathbb{R} \rightarrow S^1, \quad e(t) = e^{it}$$

which is continuous (explain why!). A nice picture of this function is obtained by first spiraling \mathbb{R} above the circle and then projecting it down, as in Figure 3.

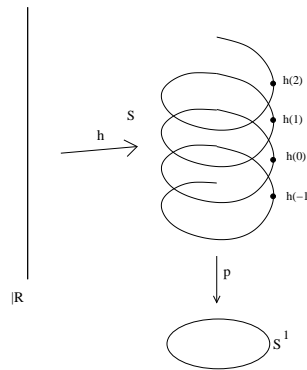

FIGURE 3.

EXERCISE 1.5. *Make Figure 3 more precise. More precisely, find an explicit subspace $S \subset \mathbb{R}^3$ which looks like the spiral, and a homeomorphism h between \mathbb{R} and S , so that the map e above is obtained by first applying h and then applying the projection p ($p(x, y, z) = (x, y)$).*

(Hint: $\{(x, y, z) \in \mathbb{R}^3 : x = \cos(z), y = \sin(z)\}$).

Note also that, if one restricts to $t \in [0, 2\pi)$, we obtain a continuous bijection

$$f : [0, 2\pi) \rightarrow S^1.$$

However, $[0, 2\pi)$ and S^1 behave quite differently as topological spaces, or, more precisely, they are not homeomorphic. Note that this does not only mean that f is not a homeomorphism; it means that neither f nor any other bijection between $[0, 2\pi)$ and S^1 is a homeomorphism. It will be only later, after some study of topological properties (e.g. compactness), that we will be able to prove this statement. At this point however, one can solve the following

EXERCISE 1.6. *Show that the map $f : [0, 2\pi) \rightarrow S^1$ is not a homeomorphism.*

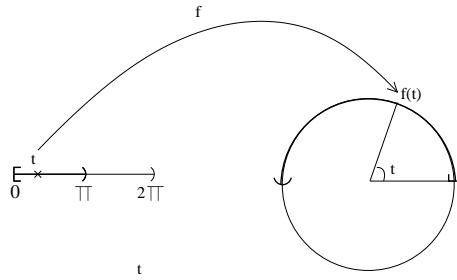

FIGURE 4.

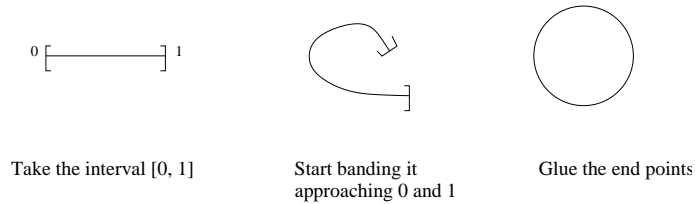

FIGURE 5.

Next, there is yet another way one can look at the unit circle: as obtained from the unit interval $[0, 1]$ by “banding it” and “gluing” its end points, as pictured in Figure 5. This “gluing process” will be made more precise later and will give yet another general method for constructing interesting topological spaces.

In general, by a (topological) circle we mean any space which is homeomorphic to S^1 . In general, they may be placed in the space in a rather non-trivial way. Some examples of circles are:

- circles S_r^1 with a radius $r > 0$ different from 1, or other circles placed somewhere else in the plane.
- pictures obtained by twisting a circle in the space, such as in Figure 6.
- even pictures which, in the space, are obtained by braking apart a circle, knotting it, and then gluing it back (see Figure 7).

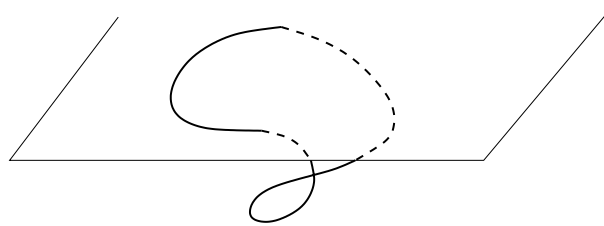

FIGURE 6.

EXERCISE 1.7. *Explain on pictures that all the spaces enumerated above are homeomorphic to S^1 . If you find it strange, try to explain to yourself what makes it look strange (is it really the circles, or is it more about the ambient spaces in which you realize the circles?).*

Similarly, by a (topological) disk we we mean any space which is homeomorphic to D^2 . For instance, the unit square

$$[0, 1] \times [0, 1] = \{(x, y) \in \mathbb{R}^2 : x, y \in [0, 1]\}$$

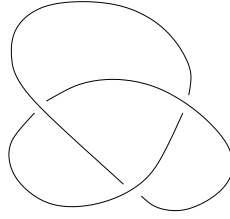
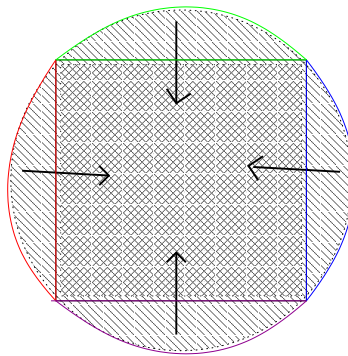

FIGURE 7.

is an important example of topological disk. More precisely, one has the following:

EXERCISE 1.8. *Show that the unit disk D^2 is homeomorphic to the unit square, by a homeomorphism which restricts to a homeomorphism between the unit circle S^1 and the boundary of the unit square.*



The unit disk and the square are homeomorphic

FIGURE 8.

4. The sphere and its higher dimensional versions

For each n , we have the n -sphere

$$S^n = \{(x_0, \dots, x_n) \in \mathbb{R}^{n+1} : (x_0)^2 + \dots + (x_n)^2 = 1\} \subset \mathbb{R}^{n+1},$$

the open $(n+1)$ -disk

$$\overset{\circ}{D}^{n+1} = \{(x_0, \dots, x_n) \in \mathbb{R}^{n+1} : (x_0)^2 + \dots + (x_n)^2 < 1\} \subset \mathbb{R}^{n+1},$$

and similarly the closed $(n+1)$ -disk D^{n+1} .

The points

$$p_N = (0, \dots, 0, 1), p_S = (0, \dots, 0, -1) \in S^n$$

are usually called the north and the south pole, respectively, and

$$S_+^n = \{(x_0, \dots, x_n) : x_n \geq 0\}, S_-^n = \{(x_0, \dots, x_n) : x_n \leq 0\}$$

are called the north and the south hemisphere, respectively. See figure 9.

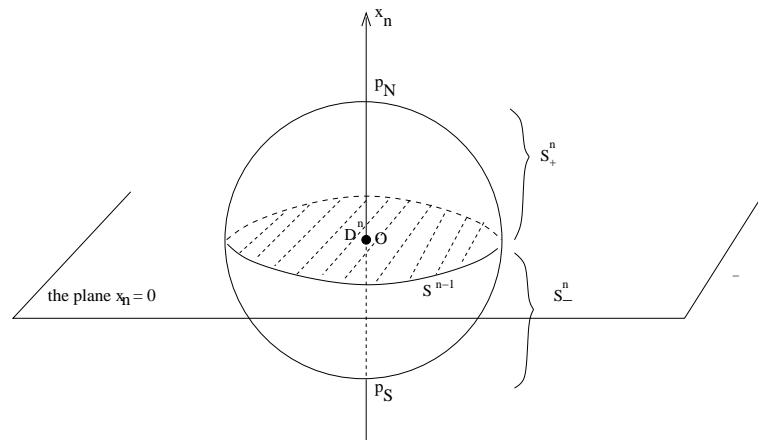

FIGURE 9.

EXERCISE 1.9. *Explain on a picture that $S_+^n \cap S_-^n$ is homeomorphic to S^{n-1} , and S_+^n and S_-^n are both homeomorphic to D^n .*

As with the circle, we will call a sphere (or an n -sphere) any space which is homeomorphic to S^2 (or S^n). Also, we call a disk (or n -disk, or open n -disk) any space which is homeomorphic to D^2 (or D^n , or $\overset{\circ}{D}^n$). For instance, the previous exercise shows that the two hemispheres S_+^n and S_-^n are n -disks, and S^n is the union of two n -disks whose intersection is an $n-1$ -sphere. This also indicates that S^n can actually be obtained by gluing two copies of D^n along their boundaries. And, still as for circles, there are many subspaces of Euclidean spaces which are spheres (or disks, or etc), but look quite different from the actual unit sphere (or unit disk, or etc). An important example has already been seen in Exercise 1.8.

Another interpretation of S^n is as adding to \mathbb{R}^n “a point at infinity”. (to be made precise later on). This can be explained using the stereographic projection

$$f : S^n - \{p_N\} \rightarrow \mathbb{R}^n$$

which associates to a point $p \in S^n$ the intersection of the line $p_N p$ with the horizontal hyperplane (see Figure 10).

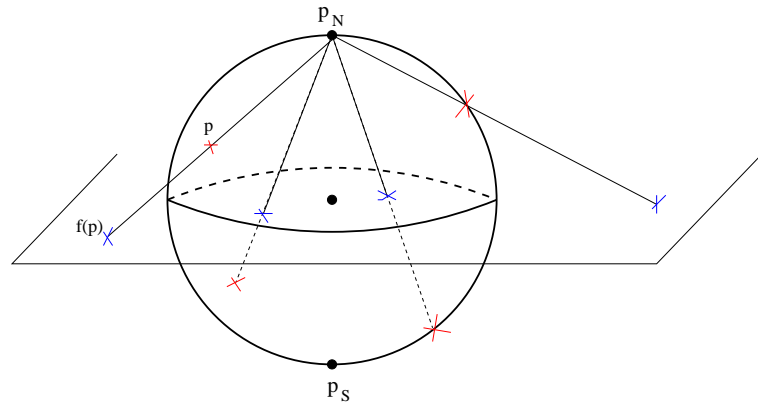

The stereographic projection (sending the red points to the blue ones)

FIGURE 10.

EXERCISE 1.10. Explain on the picture that the stereographic projection is a homeomorphism between $S^n - \{p_N\}$ and \mathbb{R}^n , and that it cannot be extended to a continuous function defined on the entire S^n . Then try to give a meaning to: “ S^n can be obtained from \mathbb{R}^n by adding a point at infinity to”. Also, find the explicit formula for f .

Here is another construction of the n -sphere. Take a copy of D^n , grab its boundary $S^{n-1} \subset D^n$ and glue it together (so that it becomes a point). You then get S^n (see Figure 11).

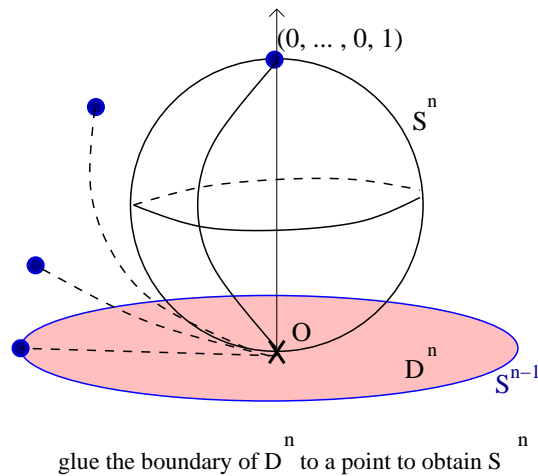

glue the boundary of D^n to a point to obtain S^n

FIGURE 11.

EXERCISE 1.11. Find explicitly the function

$$f : D^2 \rightarrow S^2$$

from Figure 11, check that $f^{-1}(p_N)$ is precisely $S^1 \subset D^2$, then generalize to arbitrary dimensions.

Another interesting way of obtaining the sphere S^2 is by taking the unit disk D^2 , dividing its boundary circle S^1 into two equal sides and gluing the two half circles as indicated in the Figure 12.

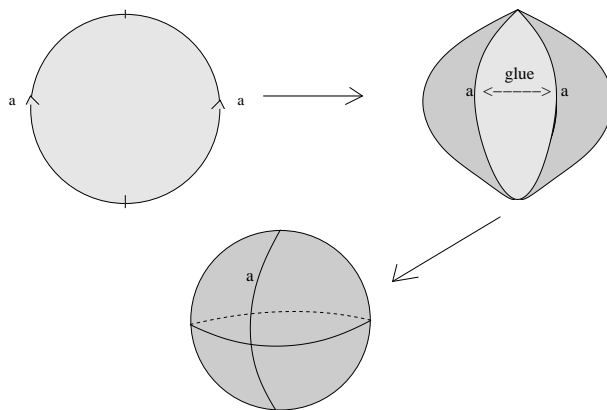

The sphere obtained from the disk by glueing the two half circles denoted by "a" on the picture

FIGURE 12.

A related construction of the sphere, which is quite important, is the following: take the disk D^2 and divide now its boundary circle into four equal sides, or take the unit square and its sides, and label them as in Figure 13. Glue now the two arcs denoted by a and the two arcs denoted by b .

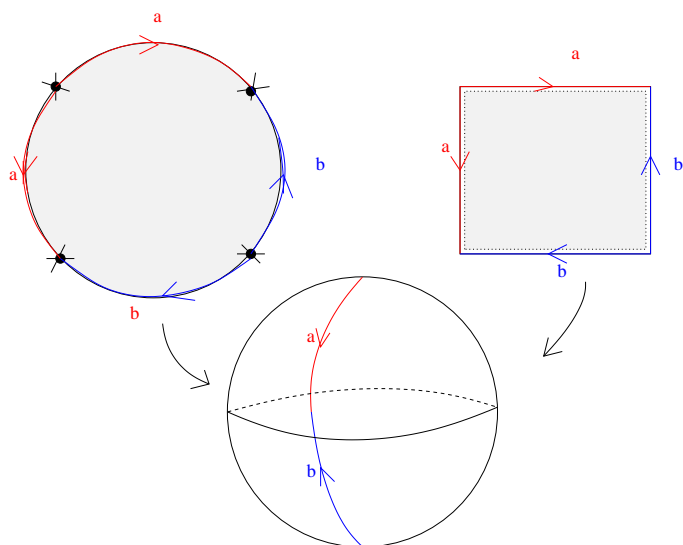

The sphere obtained from a disk or a square glueing as indicated in the picture

FIGURE 13.

5. The Moebius band

“The Moebius band” is a standard name for subspaces of \mathbb{R}^3 which are obtained from the unit square $[0, 1] \times [0, 1]$ by “gluing” two opposite sides after twisting the square one time, as shown in Figure 14. As in the discussion about the unit circle (obtained from the unit interval by “gluing”

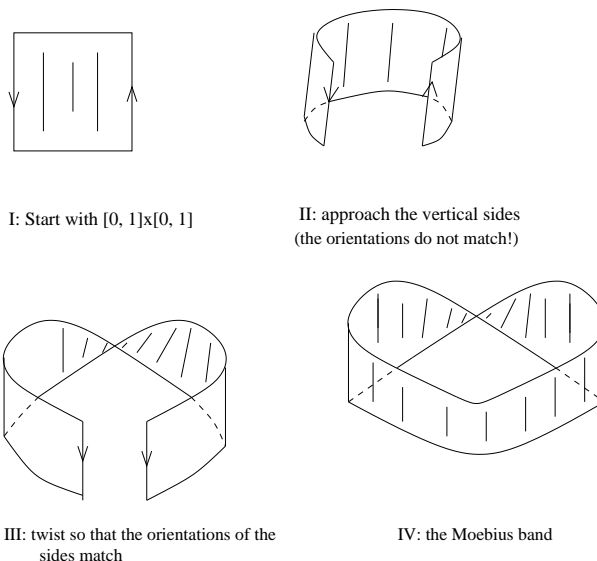

FIGURE 14.

its end points), this “gluing process” should be understood intuitively, and the precise meaning in topology will be explained later. The following exercise provides a possible parametrization of the Moebius band (inside \mathbb{R}^3).

EXERCISE 1.12. Consider

$$f : [0, 1] \times [0, 1] \rightarrow \mathbb{R}^3,$$

$$f(t, s) = ((2 + (2s - 1)\sin(\pi t))\cos(2\pi t), (2 + (2s - 1)\sin(\pi t))\sin(2\pi t), (2s - 1)\cos(\pi t)).$$

You may want to check that $f(t, s) = f(t', s')$ holds only in the following cases:

1. $(t, s) = (t', s')$.
2. $t = 0, t' = 1$ and $s' = 1 - s$.
3. $t = 1, t' = 0$ and $s' = 1 - s$.

(but this also follows from the discussion below). Based on this, explain why the image of f can be considered as the result of gluing the opposite sides of a square with the reverse orientation.

To understand where these formulas come from, and to describe explicit models of the Moebius band in \mathbb{R}^3 , we can imagine the Moebius band as obtained by starting with a segment in \mathbb{R}^3 and rotating it around its middle point, while its middle point is being rotated on a circle. See Figure 15.

The rotations take place at the same time (uniformly), and while the segment rotates by 180° , the middle point makes a full rotation (360°). To write down explicit formulas, assume that

- the circle is situated in the XOY plane, is centered at the origin, and has radius R .
- the length of the segment is $2r$ and the starting position A_0B_0 of the segment is perpendicular on XOY with middle point $P_0 = (R, 0, 0)$.
- at any moment, the segment stays in the plane through the origin and its middle point, which is perpendicular on the XOY plane.

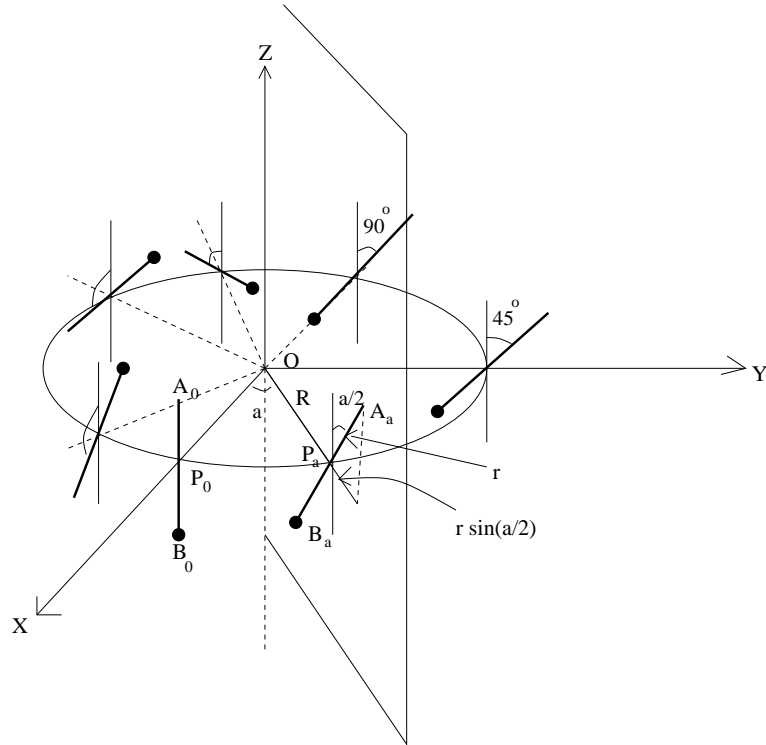

Explicit realization of the Moebius band in $\mathbb{R}^3 : M_{R,r}$

FIGURE 15.

We denote by $M_{R,r}$ the resulting subspace of \mathbb{R}^3 (note that we need to impose the condition $R > r$). To parametrize $M_{R,r}$, we parametrize the movement by the angle a which determines the middle point on the circle:

$$P_a = (R\cos(a), R\sin(a), 0).$$

At this point, the precise position of the segment, denoted A_aB_a , is determined by the angle that it makes with the perpendicular on the plane XOY through P_a ; call it b . This angle depends on a . Due to the assumptions (namely that while a goes from 0 to 2π , b only goes from 0 to π , and that the rotations are uniform), we have $b = a/2$ (see 15). We deduce

$$A_a = \{(R + r\sin(a/2))\cos(a), (R + r\sin(a/2))\sin(a), r\cos(a/2)\},$$

and a similar formula for B_a (obtained by replacing r by $-r$). Then, the Moebius band $M_{R,r}$ is:

$$(5.1) \quad M_{R,r} = \{(R + t\sin(a/2))\cos(a), (R + t\sin(a/2))\sin(a), t\cos(a/2) : a \in [0, 2\pi], t \in [-r, r]\}$$

Note that, although this depends on R and r , different choices of R and r produce homeomorphic spaces. To fix one example, one usually takes $R = 2$ and $r = 1$.

EXERCISE 1.13. *Do the following:*

1. *Make a model of the Moebius band and cut it through the middle circle. You get a new connected object. Do you think it is a new Moebius band? Then cut it again through the middle circle and see what you get.*
2. *Prove (without using a paper model) that if you cut the Moebius band through the middle circle, you obtain a (space homeomorphic to a) cylinder. What happens if you cut it again?*

6. The torus

“The torus” is a standard name for subspaces of \mathbb{R}^3 which look like a doughnut.

The simplest construction of the torus is by a gluing process: one starts with the unit square and then one glues each pair of opposite sides, as shown in Figure 16.

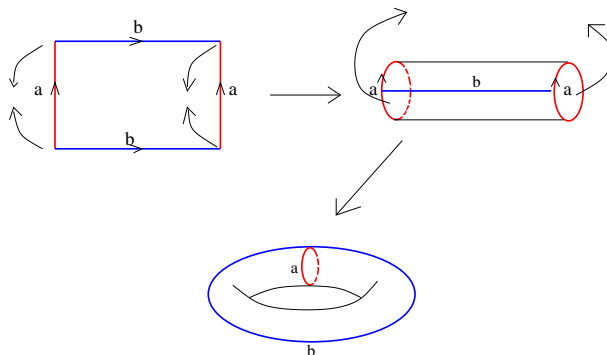
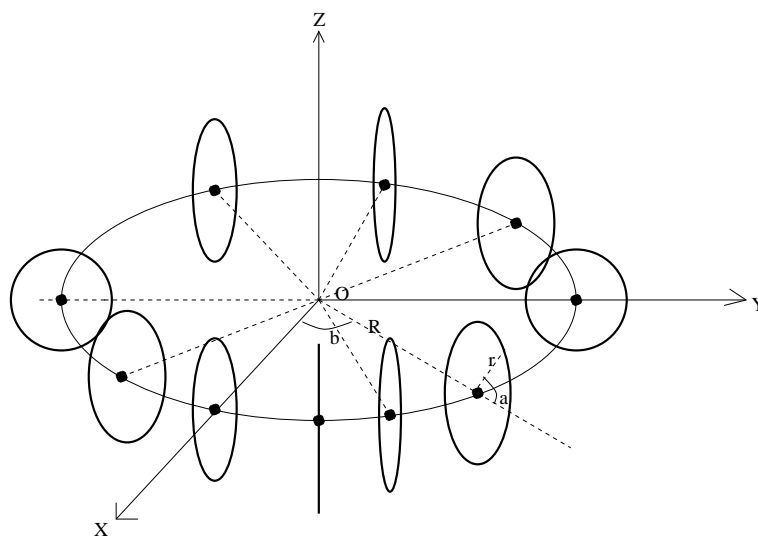

FIGURE 16.

EXERCISE 1.14. *Show that the surface of a cup with a handle is homeomorphic to the torus (what about a cup with no handle?).*

As in the case of circles, spheres, disks, etc, by a torus we mean any space which is homeomorphic to the doughnut. Let's find explicit models (in \mathbb{R}^3) for the torus. To achieve that, we will build it by placing our hand in the origin in the space, and use it to rotate a rope which at the other end has attached a non-flexible circle. The surface that the rotating circle describes is clearly a torus (see Figure 17).



$T_{R,r}$

FIGURE 17.

To describe the resulting space explicitly, we assume that the rope rotates inside the XOY plane (i.e. the circle rotates around the OZ axis). Also, we assume that the initial position of the circle is in the XOZ plane, with center of coordinates $(R, 0, 0)$, and let r be the radius of the circle ($R > r$ because the length of the rope is $R - r$). We denote by $T_{R,r}^2$ the resulting subspace of \mathbb{R}^3 . A point on $T_{R,r}^2$ is uniquely determined by the angles a and b indicated on the picture (Figure 17), and we find the parametric description:

$$(6.1) \quad T_{R,r}^2 = \{(R + r\cos(a))\cos(b), (R + r\cos(a))\sin(b), r\sin(a)\} : a, b \in [0, 2\pi] \subset \mathbb{R}^3.$$

EXERCISE 1.15. *Show that*

$$(6.2) \quad T_{R,r}^2 = \{(x, y, z) \in \mathbb{R}^3 : (\sqrt{x^2 + y^2} - R)^2 + z^2 = r^2\}.$$

Although $T_{R,r}^2$ depends on R and r , different choices of R and r produce homeomorphic spaces. There is yet another interpretation of the torus, as the Cartesian product of two circles:

$$S^1 \times S^1 = \{(z, z') : z, z' \in S^1\} \subset \mathbb{R}^2 \times \mathbb{R}^2 = \mathbb{R}^4.$$

Note that, priority, this product is in the 4-dimensional space. The torus can be viewed as a homeomorphic copy inside \mathbb{R}^3 .

EXERCISE 1.16. *Show that*

$$f : S^1 \times S^1 \rightarrow T_{R,r}^2, f(e^{ia}, e^{ib}) = (R + r\cos(a))\cos(b), (R + r\cos(a))\sin(b), r\sin(a)$$

is a bijection. Explain the map in the picture, and convince yourself that it is a homeomorphism.

Proving directly that f is a homeomorphism is not really pleasant, but the simplest way of proving that it is actually a homeomorphism will require the notion of compactness (and we will come back to this at the appropriate time).

Related to the torus is the double torus, pictured in Figure 18. Similarly, for each $g \geq 1$ integer, one can talk about the torus with g -holes.

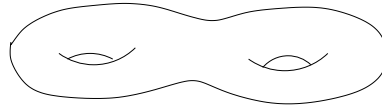

FIGURE 18.

EXERCISE 1.17. *The surface of a cup with two handles is homeomorphic to the double torus.*

Note that the double torus can be realized from two disjoint copies of the torus, by removing a small ball from each one of them, and then gluing them along the resulting circles (Figure 19).

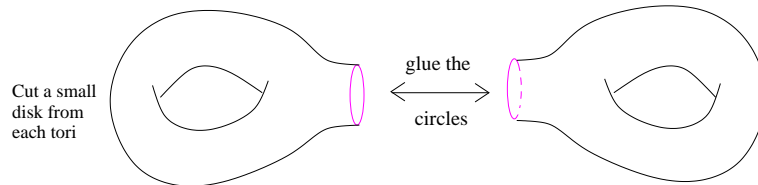

FIGURE 19.

EXERCISE 1.18. *How should one glue the sides of a pentagon so that the result is a cut torus? (Hint: see Figure 20 and try to understand it. Try to make a paper model).*

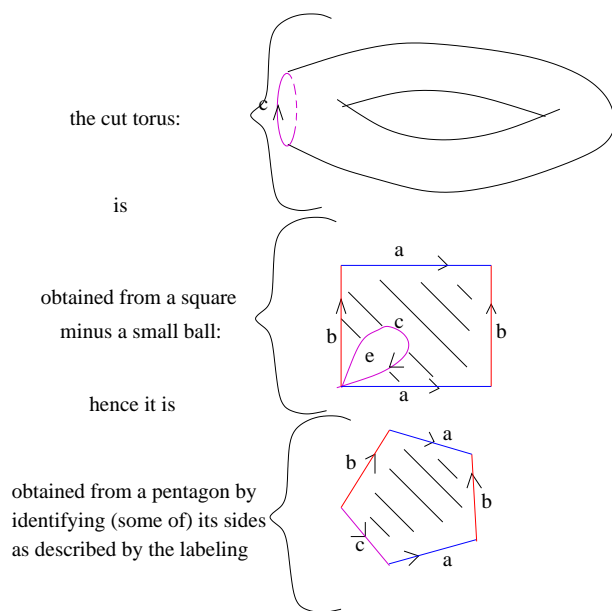

FIGURE 20.

EXERCISE 1.19. Show that the double torus can be obtained from an octagon by gluing some of its sides. (Hint: see Figure 21 and try to understand it. Try to make a paper model).

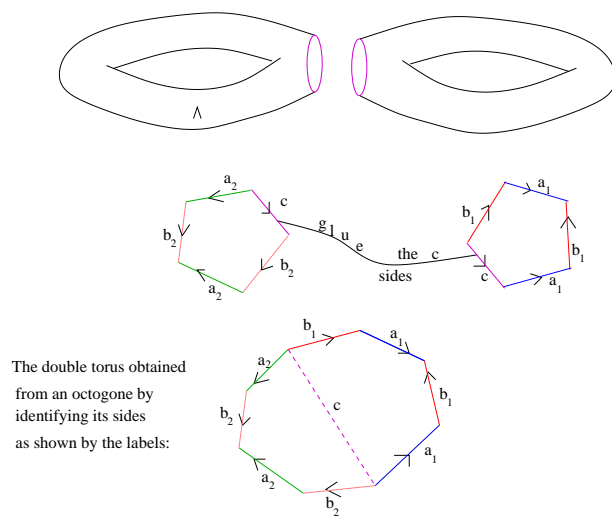

FIGURE 21.

7. The Klein bottle

We have seen that, starting from an unit square and gluing some of its sides, we can produce the sphere (Figure 13), the Moebius band (Figure 14) or the torus (Figure 16). What if we try to glue the sides differently? The next in this list of example would be the space obtained by gluing the opposite sides of the square but reversing the orientation for one of them, as indicated in Figure 22. The resulting space is called the Klein bottle, denoted here by K . Trying to repeat what we have done in the previous examples, we have trouble when “twisting the cylinder”. Is that really a problem? It is now worth having a look back at what we have already seen:

- starting with an interval and gluing its end points, although the interval sits on the real line, we did not require the gluing to be performed without leaving the real line (it would not have been possible). Instead, we used one extra-dimension to have more freedom and we obtained the circle.
- similarly, when we constructed the Moebius band or the torus, although we started in the plane with a square, we did not require the gluing to take place inside the plane (it wouldn't even have been possible). Instead, we used an extra-dimension to have more freedom for “twisting”, and the result was sitting in the space $\mathbb{R}^3 = \mathbb{R}^2 \times \mathbb{R}$.

Something very similar happens in the case of the Klein bottle: what seems to be a problem only indicates the fact that the gluing cannot be performed in \mathbb{R}^3 ; instead, it indicates that K cannot be pictured in \mathbb{R}^3 , or, more precisely, that K cannot be embedded in \mathbb{R}^3 . Instead, K can be embedded in \mathbb{R}^4 . The following exercise is an indication of that.

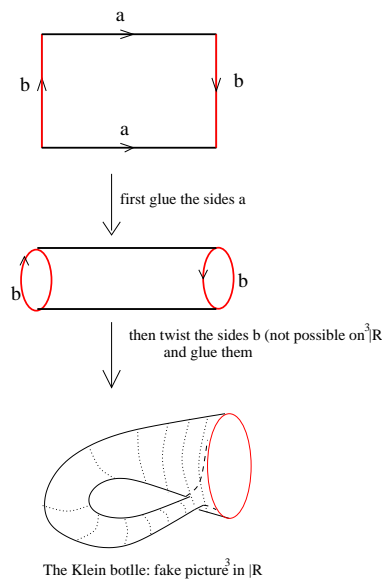

FIGURE 22.

EXERCISE 1.20. Consider the map

$$\tilde{f} : [0, 1] \times [0, 1] \rightarrow \mathbb{R}^4,$$

$$\tilde{f}(t, s) = ((2 - \cos(2\pi s)\cos(2\pi t), (2 - \cos(2\pi s)\sin(2\pi t), \sin(2\pi s)\cos(\pi t), \sin(2\pi s)\sin(\pi t)).$$

Explain why the image of this map in \mathbb{R}^4 can be interpreted as the space obtained from the square by gluing its opposite sides as indicated in the picture (hence can serve as a model for the Klein bottle).

EXERCISE 1.21. Explain how can one obtain a Klein bottle by starting with two Moebius bands and gluing them along their boundaries.
 (Hint: look at Figure 23).

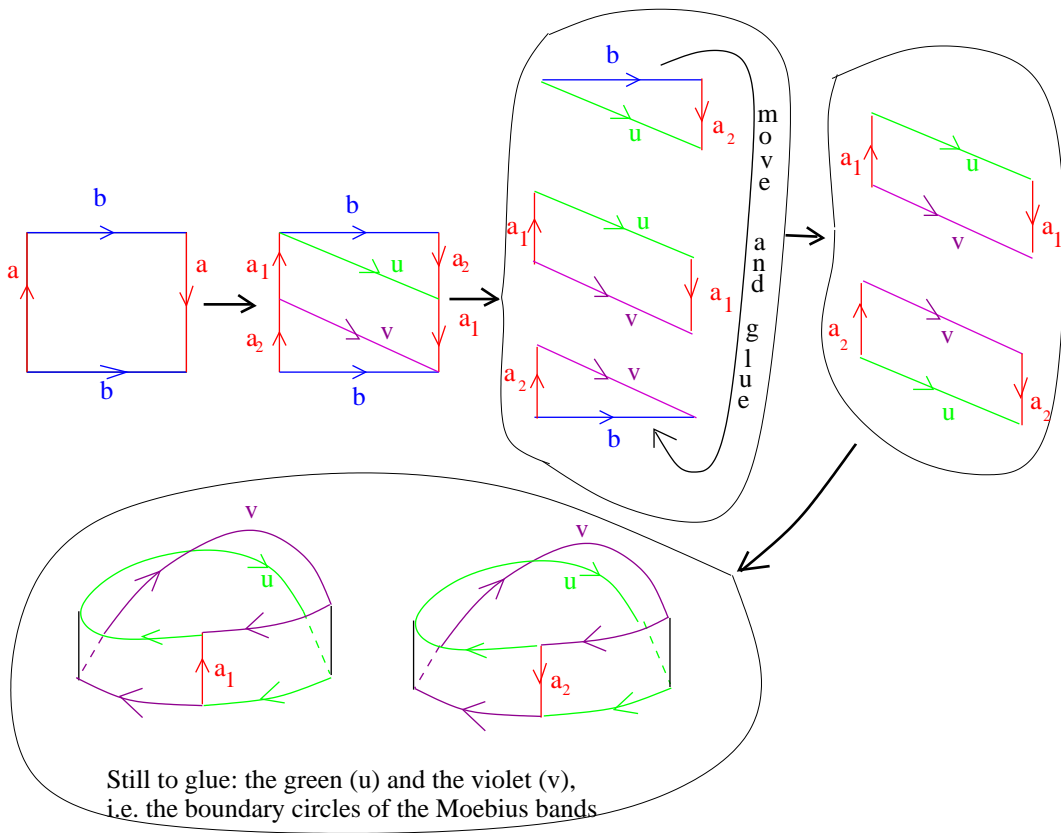

FIGURE 23.

8. The projective plane \mathbb{P}^2

In the same spirit as that of the Klein bottle, let's now try to glue the sides of the square as indicated on the left hand side of Figure 24.

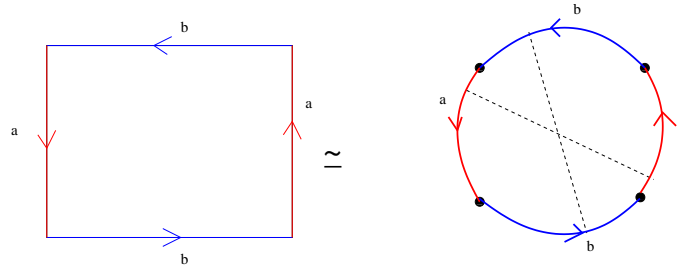

FIGURE 24.

Still as in the case of the Klein bottle, it is difficult to picture the result because it cannot be embedded in \mathbb{R}^3 (but it can be embedded in \mathbb{R}^4). However, the result is very interesting: it can be interpreted as the set of all lines in \mathbb{R}^3 passing through the origin—denoted \mathbb{P}^2 . Let's us adopt here the standard definition of the projective space:

$$\mathbb{P}^2 := \{l : l \subset \mathbb{R}^3 \text{ is a line through the origin}\},$$

(i.e. $l \subset \mathbb{R}^3$ is a one-dimensional vector subspace). Note that this is a “space” in the sense that there is a clear intuitive meaning for “two lines getting close to each other”. We will explain how \mathbb{P}^2 can be interpreted as the result of the gluing that appears in Figure 24.

Step 1: First of all, there is a simple map:

$$f : S^2 \rightarrow \mathbb{P}^2$$

which associates to a point on the sphere, the line through it and the origin. Since every line intersects the sphere exactly in two (antipodal) points, this map is surjective and has the special property:

$$f(z) = f(z') \iff z = z' \text{ or } z = -z' \text{ (} z \text{ and } z' \text{ are antipodal)}.$$

In other words, \mathbb{P}^2 can be seen as the result of gluing the antipodal points of the sphere.

Step 2: In this gluing process, the lower hemisphere is glued over the upper one. We see that, the result of this gluing can also be seen as follows: start with the upper hemisphere S^2_+ and then glue the antipodal points which are on its boundary circle.

Step 3: Next, the upper hemisphere is homeomorphic to the horizontal unit disk (by the projection on the horizontal plane). Hence we could just start with the unit disk D^2 and glue the opposite points on its boundary circle.

Step 4: Finally, recall that the unit ball is homeomorphic to the square (by a homeomorphism that sends the unit circle to the contour of the square). We conclude that our space can be obtained by the gluing indicated in the initial picture (Figure 24).

Note that, since \mathbb{P}^2 can be interpreted as the result of gluing the antipodal points of S^2 , the following exercise indicates why \mathbb{P}^2 can be seen inside \mathbb{R}^4 :

EXERCISE 1.22. Show that

$$\tilde{f} : S^2 \rightarrow \mathbb{R}^4, \tilde{f}(x, y, z) = (x^2 - y^2, xy, xz, yz)$$

has the property that, for $p, p' \in S^2$, $f(p) = f(p')$ holds if and only if p and p' are either equal or antipodal.

Note also that (a model of) the Moebius band can be seen as sitting inside (a model of) the projective plane $M \hookrightarrow \mathbb{P}^2$. To see this, recall that \mathbb{P}^2 can be seen as obtained from D^2 by gluing the antipodal points on its boundary. Consider inside D^2 the “band”

$$B = \{(x, y) \in D^2 : -\frac{1}{2} \leq y \leq \frac{1}{2}\} \subset D^2.$$

The gluing process that produces \mathbb{P}^2 affects B in the following way: it glues the “opposite curved sides” of B as in the picture (Figure 25), and gives us the Moebius band.

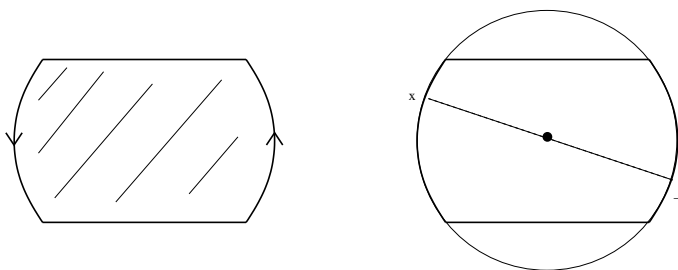

The Moebius band inside the projective plane

FIGURE 25.

Paying attention to what happens to $D^2 - B$ in the gluing process, you can now try the following.

EXERCISE 1.23. Indicate how \mathbb{P}^2 can be obtained by starting from a Moebius band and a disk, and glue them along the boundary circle.

9. Gluing (or quotients)

We have already seen some examples of spaces obtained by gluing some of their points. When the gluing becomes less intuitive or more complicated, we start asking ourselves:

1. What gluing really means?
2. What is the result of such a gluing?

Here we address these questions. In examples such the circle, torus or Moebius band, the answer was clear intuitively:

1. Gluing had the intuitive meaning- done effectively by using paper models.
2. the result was a new object, or rather a shape (it depends on how much we twist and pull the piece of paper).

Emphasize again that there was no preferred torus or Moebius band, but rather models for it (each two models being homeomorphic). Moving to the Klein bottle, things started to become less intuitive, since the result of the gluing cannot be pictured in \mathbb{R}^3 (and things become probably even worse in the case of the projective plane). But, as we explained above, if we use an extra-dimension, the Klein bottle exist in \mathbb{R}^4 - and Exercise 1.20 produces a subset of \mathbb{R}^4 which is an explicit *model* for it.

And things become much worse if we now start performing more complicated gluing of more complicated objects (one can even get “spaces” which cannot be “embedded” in any of the spaces \mathbb{R}^n !). It is then useful to have a more conceptual (but abstract) understanding of what “gluing” and “the result of a gluing” means.

Start with a set X and assume that we want to glue some of its points. Which points we want to glue form the initial “gluing data”, which can be regarded as a subset

$$R \subset X \times X$$

consisting of all pairs (x, y) with the property that we want x and y to be glued. This subset must have some special properties (e.g., if we want to glue x to y , y to z , then we also have to glue x to z). This brings us to the notions of equivalence relation that we now recall.

DEFINITION 1.2. An equivalence relation on a set X is a subset $R \subset X \times X$ satisfying the following:

1. If $(x, y) \in R$ and $(y, z) \in R$, then $(x, z) \in R$.
2. If $(x, y) \in R$ then also $(y, x) \in R$.
3. $(x, x) \in R$ for all $x \in X$.

Hence, as a gluing data we start with any equivalence relation on X .

EXERCISE 1.24. Describe explicitly the equivalence relation R on the square $X = [0, 1] \times [0, 1]$ which describe the gluing that we performed to construct the Moebius band. Similarly for the equivalence relation on the disk that described the gluing from Figure 11.

What should the result of the gluing be? First of all, it is going to be a new set Y . Secondly, any point of X should give a point in Y , i.e. there should be a function $\pi : X \rightarrow Y$ which should be surjective (the gluing should not introduce new points). Finally, π should really reflect the gluing, in the sense that $\pi(x) = \pi(y)$ should only happen when $(x, y) \in R$. Here is the formal definition.

DEFINITION 1.3. Given an equivalence relation R on a set X , a quotient of X modulo R is a pair (Y, π) consisting of a set Y and a surjection $\pi : X \rightarrow Y$ (called the quotient map) with the property that

$$\pi(x) = \pi(y) \iff (x, y) \in R.$$

Hence, a quotient of X modulo R can be viewed as a model for the set obtained from X by gluing its points according to R .

EXERCISE 1.25. *Describe the equivalence relation R on $[0, 1] \times [0, 1]$ that encodes the gluing that we performed when constructing the torus. Then prove that the explicit model $T_{R,r}^2$ of the torus given by formula (6.2) is a quotient of $[0, 1] \times [0, 1]$ modulo R , in the sense of the previous definition (of course, you also have to describe the map π).*

One can wonder “how many” abstract quotients can one build? Well, only one- up to isomorphism. More precisely:

EXERCISE 1.26. *Show that if (Y_1, π_1) and (Y_2, π_2) are two quotients of X modulo R , then there exists and is unique a bijection $f : Y_1 \rightarrow Y_2$ such that $f \circ \pi_1 = \pi_2$.*

One can also wonder: can one always build quotients? The answer is yes but, in full generality (for arbitrary X and R), one has to construct the model abstractly. Namely, for each $x \in X$ we define the R -equivalence class of x as

$$R(x) := \{y \in X : (x, y) \in R\}$$

(a subset of X) and define

$$X/R = \{R(x) : x \in X\}$$

(a new set whose elements are subsets of X). There is a simple function

$$\pi_R : X \rightarrow X/R, \quad \pi_R(x) = R(x),$$

called the canonical projection. This is the abstract quotient of X modulo R .

EXERCISE 1.27. *Show that:*

1. *For any equivalence relation R on a set X , $(X/R, \pi_R)$ is a quotient of X modulo R .*
2. *For any surjective map, $f : X \rightarrow Y$, there is a unique relation R on X such that (Y, f) is a quotient of X modulo R .*

REMARK 1.4. This discussion has been set-theoretical, so let’s now go back to the case that X is a subset of some \mathbb{R}^n , and R is some equivalence relation on X . It is clear that, in such a “topological setting”, we do not look for arbitrary models (quotients), but only for those which are in agreement with our intuition. In other words we are looking for “topological quotients” (“topological models”). What that really means will be made precise later on (since it requires the precise notion of topology). As a first attempt one could look for quotients (Y, π) of X modulo R with the property that

- (1) Y is itself is a subspace of some \mathbb{R}^k .
- (2) π is continuous.

These requirements pose two problems:

- Insisting that Y is a subspace of some \mathbb{R}^k is too strong- see e.g. the exercise below. (Instead, Y will be just “topological space”).
- The list of requirements is not complete. This can already be seen when $R = \{(x, x) : x \in X\}$ (i.e. when no gluing is required). Clearly, in this case, a “topological model” is X itself, and any other model should be homeomorphic to X . However, the requirements above only say that $\pi : X \rightarrow Y$ is a continuous bijection which, as we have already seen, does not imply that π is a homeomorphism.

As we already said, the precise list of requirements will be made precise later on. (There is a good news however: if X is “compact”, then any quotient (Y, π) of X modulo R which satisfies (1) and (2) above, is a good topological model!).

EXERCISE 1.28. Let $X = S^1$, and we want to glue any two points $e^{ia}, e^{ib} \in S^1$ with the property that $b = a + 2\pi\sqrt{2}$. Show that there is no model (Y, π) with Y -a subset of some space \mathbb{R}^n and $\pi : X \rightarrow Y$ continuous.

EXERCISE 1.29. Let

$$\mathbb{P}^n := \{l : l \subset \mathbb{R}^{n+1} \text{ is a line through the origin}\},$$

(i.e. $l \subset \mathbb{R}^{n+1}$ is a one-dimensional vector subspace). Explain how \mathbb{P}^n (with the appropriate quotient maps) can be seen as:

1. a quotient of \mathbb{R}^{n+1} modulo an equivalence relation that you have to specify (see second part of Exercise 1.27).
2. obtained from S^n by gluing every pairs of its antipodal points.
3. obtained from D^n by gluing every pair of antipodal points situated on the boundary sphere S^{n-1} .

10. Metric aspects versus topological ones

Of course, most of what we discussed so far can be done within the world of metric spaces—a notion that did allow us to talk about convergence, continuity, homeomorphisms. There are however several reasons to allow for more flexibility and leave this world.

One was already indicated in Exercise 1.1 which shows that metric spaces do not encode convergence faithfully. Very different looking metrics on \mathbb{R}^n (e.g. the Euclidean d and the square one ρ in that exercise) can induce the same notion of convergence, i.e. they induce the same “topology” on \mathbb{R}^n —the one that we sense with our intuition. Of course, that exercise just tells us that $\text{Id} : (\mathbb{R}^n, d) \rightarrow (\mathbb{R}^n, \rho)$ is a homeomorphism, or that d and ρ induce the same “topology” on \mathbb{R}^n (we will make this precise a few lines below).

The key of understanding the “topological content” of metrics (i.e. the one that allows us to talk about convergent sequences) is the notion of opens with respect to a metric. This is the first step toward the abstract notion of topological space.

DEFINITION 1.5. *Let (X, d) be a metric space. For $x \in X$, $\epsilon > 0$ one defines the open ball with center x and radius ϵ (with respect to d):*

$$B_d(x, \epsilon) = \{y \in X : d(y, x) < \epsilon\}.$$

A set $U \subset X$ is called open with respect to d if

$$(10.1) \quad \forall x \in U \exists \epsilon > 0 \text{ such that } B(x, \epsilon) \subset U.$$

The topology induced by d , denoted \mathcal{T}_d , is the collection of all such opens $U \subset X$.

With this we have:

EXERCISE 1.30. *Let d and d' be two metrics on the set X . Show that convergence in X with respect to d coincides with convergence in X with respect to d' if and only if $\mathcal{T}_d = \mathcal{T}_{d'}$.*

It is not a surprise that the notion of convergence and continuity can be rephrased using opens only.

EXERCISE 1.31. *Let (X, d) be a metric space, $(x_n)_{n \geq 1}$ a sequence in X , $x \in X$. Then $(x_n)_{n \geq 1}$ converges to x (in (X, d)) if and only if: for any open $U \in \mathcal{T}_d$ containing x , there exists an integer n_U such that*

$$x_n \in U \quad \forall \quad n \geq n_U.$$

EXERCISE 1.32. *Let (X, d) and (Y, d') be two metric spaces, and $f : X \rightarrow Y$ a function. Then f is continuous if and only if*

$$f^{-1}(U) \in \mathcal{T}_d \quad \forall \quad U \in \mathcal{T}_{d'}.$$

The main conclusion is that the topological content of a metric space (X, d) is retained by the family \mathcal{T}_d of opens in the metric space. This is the first example of a topology. I would like to emphasize here that our previous discussion does NOT mean that we should not use metrics and that we should not talk about metric spaces. Not at all! When metrics are around, we should take advantage of them and use them! However, one should be aware that some of the simple operations that we make with metric spaces (e.g. gluing) may take us out of the world of metric spaces. But, even when staying within the world of metric spaces, it is extremely useful to be aware of what depends on the metric itself and what just on the topology that the metric induces. We give two examples here.

Compactness The first example is the notion of compactness. You have probably seen this notion for subspaces of \mathbb{R}^n : a subset \mathbb{R}^n is called compact if it is bounded and closed in \mathbb{R}^n (see Dictaat Inleiding Analyse, Stelling 4.20, page 78). With this definition it is very easy to work

with compactness (... of subspaces of \mathbb{R}^n). E.g., the torus, the Moebius band, etc, they are all compact. However, one should be careful here: what we can say is that all the models of the torus, etc that we built are compact. What about the other ones? In other words, is compactness a topological condition? I.e., if $A \subset \mathbb{R}^n$ and $B \subset \mathbb{R}^m$ are homeomorphic, is it true that the compactness of A implies the compactness of B ? With the previous definition of compactness, the answer may be no, as both the condition “bounded” and “closed” make reference to the way that A sits inside \mathbb{R}^n , and even to the Euclidean metric on \mathbb{R}^n (for boundedness). See also Exercise 1.34 below. However, as we shall see, the answer is: yes, compactness is a topological property (and this is extremely useful).

Completeness Another notion that is extremely important when we talk about metric spaces is that of completeness. Recall (see Dictaat Inleiding Analyse, page 74):

DEFINITION 1.6. *Given a metric space (X, d) and a sequence $(x_n)_{n \geq 1}$ in X , we say that $(x_n)_{n \geq 1}$ is a Cauchy sequence if*

$$\lim_{n, m \rightarrow \infty} d(x_n, x_m) = 0,$$

i.e., for each $\epsilon > 0$, there exists an integer n_ϵ such that

$$d(x_n, x_m) < \epsilon$$

for all $n, m \geq n_\epsilon$. One says that (X, d) is complete if any Cauchy sequence is convergent. We say that $A \subset X$ is complete if A , together with the restriction of d to A , is complete.

For instance, \mathbb{R}^n with the Euclidean metric is complete, as is any closed subspace of \mathbb{R}^n . Now, is completeness a topological property? This time, the answer is no, as the following exercise shows. But, again, this does not mean that we should ignore completeness in this course (and we will not). We should be aware that it is not a topological property, but use it whenever possible!

EXERCISE 1.33. On \mathbb{R} we consider the metric $d'(x, y) = |e^x - e^y|$. Show that

1. d' induces the same topology on \mathbb{R} as the Euclidean metric d .
2. although (\mathbb{R}, d) is complete, (\mathbb{R}, d') is not.

(Hint: $\log(\frac{1}{n})$).

EXERCISE 1.34. For a metric space (X, d) we define $\hat{d}: X \times X \rightarrow \mathbb{R}$ by

$$\hat{d}(x, y) = \min\{d(x, y), 1\}.$$

Show that:

1. \hat{d} is a metric inducing the same topology on X as d .
2. (X, d) is complete if and only if (X, \hat{d}) is.

CHAPTER 2

Topological spaces

1. Topological spaces
2. Continuous functions; homeomorphisms
3. Neighborhoods and convergent sequences
4. Inside a topological space: closure, interior and boundary
5. Hausdorffness; 2nd countability; topological manifolds
6. More on separation
7. More exercises

1. Topological spaces

We start with the abstract definition of topological spaces.

DEFINITION 2.1. A topology on a set X is a collection \mathcal{T} of subsets of X , satisfying the following axioms:

- (T1) \emptyset and X belong to \mathcal{T} .
- (T2) The intersection of any two sets from \mathcal{T} is again in \mathcal{T} .
- (T3) The union of any collection of sets of \mathcal{T} is again in \mathcal{T} .

A topological space is a pair (X, \mathcal{T}) consisting of a set X and a topology \mathcal{T} on X .

A subset $U \subset X$ is called open in the topological space (X, \mathcal{T}) if it belongs to \mathcal{T} .

A subset $A \subset X$ is called closed in the topological space (X, \mathcal{T}) if $X - A$ is open.

Given two topologies \mathcal{T} and \mathcal{T}' on X , we say that \mathcal{T}' is larger (or finer) than \mathcal{T} , or that \mathcal{T} is smaller (or coarser) than \mathcal{T}' , if $\mathcal{T} \subset \mathcal{T}'$.

EXERCISE 2.1. Show that, in a topological space (X, \mathcal{T}) , any finite intersection of open sets is open: for each $k \geq 1$ integer, $U_1, \dots, U_k \in \mathcal{T}$, one must have $U_1 \cap \dots \cap U_k \in \mathcal{T}$. Would it be reasonable to require that arbitrary intersections of opens sets is open? What can you say about intersections or union of closed subsets of (X, \mathcal{T}) ?

TERMINOLOGY/CONVENTIONS 2.2. When referring to a topological space (X, \mathcal{T}) , when no confusion may arise, we will simply say that “ X is a topological space”. Also, the opens in (X, \mathcal{T}) will simply be called “opens in X ” (and similarly for “closed”).

In other words, we will not mention \mathcal{T} all the time; its presence is implicit in the statement “ X is a topological space”, which allows us to talk about “opens in X ”.

EXAMPLE 2.3. (*Extreme topologies*) On any set X we can define the following:

1. The trivial topology on X , $\mathcal{T}_{\text{triv}}$: the topology whose open sets are only \emptyset and X .
2. The discrete topology on X , \mathcal{T}_{dis} : the topology whose open sets are all subsets of X .
3. The co-finite topology on X , \mathcal{T}_{cf} : the topology whose open sets are the empty set and complements of finite subsets of X .
4. The co-countable topology on X , \mathcal{T}_{cc} : the topology whose open sets are the empty set and complements of subsets of X which are at most countable.

An important class of examples comes from metrics.

PROPOSITION 2.4. For any metric space (X, d) , the family \mathcal{T}_d of opens in X with respect to d is a topology on X . Moreover, this is the smallest topology on X with the property that it contains all the balls

$$B_d(x; r) = \{y \in X : d(x, y) < r\} \quad (x \in X, r > 0).$$

PROOF. Axiom (T1) is immediate. To prove (T2), let $U, V \in \mathcal{T}_d$ and we want to prove that $U \cap V \in \mathcal{T}_d$. We have to show that, for any point $x \in U \cap V$, there exists $r > 0$ such that $B_d(x, r) \subset U \cap V$. So, let $x \in U \cap V$. That means that $x \in U$ and $x \in V$. Since $U, V \in \mathcal{T}_d$, we find $r_1 > 0$ and $r_2 > 0$ such that

$$B_d(x, r_1) \subset U, B_d(x, r_2) \subset V.$$

Then $r = \min\{r_1, r_2\}$, has the desired property: $B_d(x, r) \subset U \cap V$.

To prove axiom (T3), let $\{U_i : i \in I\}$ be a family of elements $U_i \in \mathcal{T}_d$ (indexed by a set I) and we want to prove that $U := \cup_{i \in I} U_i \in \mathcal{T}_d$. We have to show that, for any point $x \in U$, there exists $r > 0$ such that $B_d(x, r) \subset U$. So, let $x \in U$. Then $x \in U_i$ for some $i \in I$; since $U_i \in \mathcal{T}_d$, we find $r > 0$ such that $B_d(x, r) \subset U_i$. Since $U_i \subset U$, r has the desired property $B_d(x, r) \subset U$.

Assume now that \mathcal{T} is a topology on X which contains all the balls and we prove that $\mathcal{T}_d \subset \mathcal{T}$. Let $U \in \mathcal{T}_d$ and we prove $U \in \mathcal{T}$. From the definition of \mathcal{T}_d , for each $x \in U$ we find $r_x > 0$ with

$$\{x\} \subset B(x; r_x) \subset U.$$

Taking the union over all $x \in U$ we deduce that

$$U \subset \cup_{x \in U} B(x; r_x) \subset U.$$

Hence $U = \cup_{x \in U} B(x; r_x)$ and then, since all the balls belong to \mathcal{T} , U belongs itself to \mathcal{T} . \square

DEFINITION 2.5. A topological space (X, \mathcal{T}) is called metrizable if there exists a metric d on X such that $\mathcal{T} = \mathcal{T}_d$.

REMARK 2.6. And here is one of the important problems in topology:

which topological spaces are metrizable?

More exactly, one would like to find the special properties that a topology must have so that it is induced by a metric. Such properties will be discussed throughout the entire course.

The most basic metric is the Euclidean metric on \mathbb{R}^n which was behind the entire discussion of Chapter 1. Also, the Euclidean metric can be (and was) used as a metric on any subset $A \subset \mathbb{R}^n$.

TERMINOLOGY/CONVENTIONS 2.7. The topology on \mathbb{R}^n induced by the Euclidean metric is called the Euclidean topology on \mathbb{R}^n . Whenever we talk about “the space \mathbb{R}^n ” without specifying the topology, we always mean the Euclidean topology. Similarly for subsets $A \subset \mathbb{R}^n$.

For other examples of topologies on \mathbb{R} you should look at Exercise 2.19. General methods to construct topologies will be discussed in the next chapter. Here we mention:

EXAMPLE 2.8. (*subspace topology*) In general, given a topological space (X, \mathcal{T}) , any subset $A \subset X$ inherits a topology on its own. More precisely, one defines the restriction of \mathcal{T} to A , or the topology induced by \mathcal{T} on A (or simply the induced topology on A) as:

$$\mathcal{T}|_A := \{B \subset A : B = U \cap A \text{ for some } U \in \mathcal{T}\}.$$

EXERCISE 2.2. Show that $\mathcal{T}|_A$ is indeed a topology.

TERMINOLOGY/CONVENTIONS 2.9. Given a topological space (X, \mathcal{T}) , whenever we deal with a subset $A \subset X$ without specifying the topology on it, we always consider A endowed with $\mathcal{T}|_A$.

To remove ambiguities, you should look at Exercise 2.23.

DEFINITION 2.10. Given a topological space (X, \mathcal{T}) and $A, B \subset X$, we say that B is open in A if $B \subset A$ and B is an open in the topological space $(A, \mathcal{T}|_A)$. Similarly, we say that B is closed in A if $B \subset A$ and B is closed in the topological space $(A, \mathcal{T}|_A)$.

EXERCISE 2.3. The interval $[0, 1) \subset \mathbb{R}$:

- (i) is neither open nor closed in $(-1, 2)$.
- (ii) is open in $[0, \infty)$ but it is not closed in $[0, \infty)$.
- (iii) is closed in $(-1, 1)$ but it is not open in $(-1, 1)$.
- (iv) it is both open and closed in $(-\infty, -1) \cup [0, 1) \cup (2, \infty)$.

2. Continuous functions; homeomorphisms

DEFINITION 2.11. Given two topological spaces (X, \mathcal{T}_X) and (Y, \mathcal{T}_Y) , and a function $f : X \rightarrow Y$, we say that f is continuous (with respect to the topologies \mathcal{T}_X and \mathcal{T}_Y) if:

$$f^{-1}(U) \in \mathcal{T}_X \quad \forall \quad U \in \mathcal{T}_Y.$$

EXERCISE 2.4. Show that a map $f : X \rightarrow Y$ between two topological spaces (X with some topology \mathcal{T}_X , and Y with some topology \mathcal{T}_Y) is continuous if and only if $f^{-1}(A)$ is closed in X for any closed subspace A of Y .

EXAMPLE 2.12. Some extreme examples first:

1. If Y is given the trivial topology then, for any other topological space (X, \mathcal{T}_X) , any function $f : (X, \mathcal{T}_X) \rightarrow (Y, \mathcal{T}_{\text{triv}})$ is automatically continuous.
2. If X is given the discrete topology then, for any other topological space (Y, \mathcal{T}_Y) , any function $f : (X, \mathcal{T}_{\text{dis}}) \rightarrow (Y, \mathcal{T}_Y)$ is automatically continuous.
3. The composition of two continuous functions is continuous: If $f : (X, \mathcal{T}_X) \rightarrow (Y, \mathcal{T}_Y)$ and $g : (Y, \mathcal{T}_Y) \rightarrow (Z, \mathcal{T}_Z)$ are continuous, then so is $g \circ f : (X, \mathcal{T}_X) \rightarrow (Z, \mathcal{T}_Z)$. Indeed, for any $U \in \mathcal{T}_Z$, $V := g^{-1}(U) \in \mathcal{T}_Y$, hence

$$(f \circ g)^{-1}(U) = g^{-1}(f^{-1}(U)) = g^{-1}(V)$$

must be in \mathcal{T}_X .

4. For any topological space (X, \mathcal{T}) , the identity map $\text{Id}_X : (X, \mathcal{T}) \rightarrow (X, \mathcal{T})$ is continuous. More generally, if \mathcal{T}_1 and \mathcal{T}_2 are two topologies on X , then the identity map $\text{Id}_X : (X, \mathcal{T}_1) \rightarrow (X, \mathcal{T}_2)$ is continuous if and only if \mathcal{T}_2 is smaller than \mathcal{T}_1 .

EXAMPLE 2.13. Given $f : X \rightarrow Y$ a map between two metric spaces (X, d) and (Y, d') , Exercise 1.32 says that $f : X \rightarrow Y$ is continuous as a map between metric spaces (in the sense discussed in the previous chapter) if and only if $f : (X, \mathcal{T}_d) \rightarrow (Y, \mathcal{T}_{d'})$ is continuous as a map between topological spaces.

That is good news: all functions $f : \mathbb{R}^n \rightarrow \mathbb{R}^m$ between Euclidean spaces that we knew (e.g. from the Analysis course) to be continuous, are continuous in the sense of the previous definition as well. This applies in particular to all the elementary functions such as polynomial ones, exp, sin, cos, etc.

Even more, if $f : \mathbb{R}^n \rightarrow \mathbb{R}^m$ is continuous and $A \subset \mathbb{R}^n$, $B \subset \mathbb{R}^m$ such that $f(A) \subset B$, then the restriction of f to A , viewed as a function from A to B , is automatically continuous (check that!). Finally, the usual operations of continuous functions are continuous:

EXERCISE 2.5. Let X be a topological space, $f_1, \dots, f_n : X \rightarrow \mathbb{R}$ and consider

$$f := (f_1, \dots, f_n) : X \rightarrow \mathbb{R}^n.$$

Show that f is continuous if and only if f_1, \dots, f_n are. Deduce that the sum and the product of two continuous functions $f, g : X \rightarrow \mathbb{R}$ are themselves continuous.

DEFINITION 2.14. Given two topological spaces (X, \mathcal{T}_X) and (Y, \mathcal{T}_Y) , a homeomorphism between them is a bijective function $f : X \rightarrow Y$ with the property that f and f^{-1} are continuous. We say that X and Y are homeomorphic if there exists a homeomorphism between them.

REMARK 2.15. In the definition of the notion of homeomorphism (and as we have seen already in the previous chapter), it is not enough to require that $f : (X, \mathcal{T}_X) \rightarrow (Y, \mathcal{T}_Y)$ is continuous and bijective (it may happen that f^{-1} is not continuous!). For f^{-1} to be continuous, one would need that for each $U \subset X$ open, $f(U) \subset Y$ is open. Functions with this property (that send opens to opens) are called open maps.

For instance, the function

$$f : [0, 2\pi) \rightarrow S^1, f(t) = (\cos(t), \sin(t)),$$

that we also discussed in the previous chapter, is continuous and bijective, but it is not a homeomorphism. More precisely, it is not open: $[0, \pi)$ is open in X , while $f([0, 2\pi))$ is a half circle closed at one end and open at the other- hence not open (Figure 4 in the previous chapter).

REMARK 2.16. We would like to emphasize that the notion of “homeomorphism” is the correct notion “isomorphism in the topological world”. A homeomorphism $f : X \rightarrow Y$ allows us to move from X to Y and backwards carrying along any topological argument (i.e. any argument which is based on the notion of opens) and without losing any topological information. For this reason, in topology, homeomorphic spaces are not viewed as being different from each other.

Another important question in Topology is:

how do we decide if two spaces are homeomorphic or not?

Actually, all the topological properties that we will discuss in this course (the countability axioms, Hausdorffness, connectedness, compactness, etc) could be motivated by this problem. For instance, try to prove now that $(0, 2)$ and $(0, 1) \cup (1, 2)$ are not homeomorphic (if you managed, you have probably discovered the notion of connectedness). Try to prove that the open disk and the closed disk are not homeomorphic (if you managed, you have probably discovered the notion of compactness). Let us be slightly more precise about the meaning of “topological property”.

TERMINOLOGY/CONVENTIONS 2.17. *We call topological property any property \mathcal{P} of topological spaces (that a space may or may not satisfy) such that, if X and Y are homeomorphic, then X has the property \mathcal{P} if and only if Y has it.*

For instance, the property of being metrizable (see Definition 2.5) is a topological property:

EXERCISE 2.6. Let X and Y be two homeomorphic topological spaces. Show that X is metrizable if and only if Y is.

DEFINITION 2.18. *A continuous function $f : X \rightarrow Y$ (between two topological spaces) is called an embedding if f is injective and, as a function from X to its image $f(X)$, it is a homeomorphism (where $f(X) \subset Y$ is endowed with the induced topology).*

EXAMPLE 2.19. There are injective continuous maps that are not embeddings. This is the case already with the function $f(\alpha) = (\cos(\alpha), \sin(\alpha))$ already discussed, viewed as a function $f : [0, 2\pi) \rightarrow \mathbb{R}^2$.

REMARK 2.20. Again, one of the important questions in Topology is:

understand when a space X can be embedded in another given space Y

When $Y = \mathbb{R}^2$, that means intuitively that X can be pictured topologically on a piece of paper. When $Y = \mathbb{R}^3$, it is about being able to make models of X in space. Of course, one of the most interesting versions of this question is whether X can be embedded in some \mathbb{R}^N for some N . As we have seen, the torus and the Moebius band can be embedded in \mathbb{R}^3 ; one can *prove* that they cannot be embedded in \mathbb{R}^2 ; also, one can *prove* that the Klein bottle cannot be embedded in \mathbb{R}^3 . However, all these proofs are far from trivial.

3. Neighborhoods and convergent sequences

DEFINITION 2.21. Given a topological space (X, \mathcal{T}) , $x \in X$, a neighborhood of x (in the topological space (X, \mathcal{T})) is any subset $V \subset X$ with the property that there exists $U \in \mathcal{T}$ such that

$$x \in U \subset V.$$

When V is itself open, we call it an open neighborhood of x . We denote:

$$\mathcal{T}(x) := \{U \in \mathcal{T} : x \in U\}, \quad \mathcal{N}(x) = \{V \subset X : \exists U \in \mathcal{T}(x) \text{ such that } U \subset V\}.$$

EXAMPLE 2.22. In a metric space (X, d) , from the definition of \mathcal{T}_d we deduce:

$$(3.1) \quad \mathcal{N}(x) = \{V \subset X : \exists \epsilon > 0 \text{ such that } B(x, \epsilon) \subset V\}.$$

REMARK 2.23. What are neighborhoods good for? They are the “topological pieces” which are relevant when looking at properties which are “local”, in the sense that they depend only on what happens “near points”. For instance, we can talk about continuity at a point.

DEFINITION 2.24. We say that a function $f : (X, \mathcal{T}_X) \rightarrow (Y, \mathcal{T}_Y)$ is continuous at x if

$$(3.2) \quad f^{-1}(V) \in \mathcal{N}_X(x) \quad \forall V \in \mathcal{N}_Y(f(x)).$$

PROPOSITION 2.25. A function is continuous if and only if it is continuous at all points.

PROOF. Assume first that f is continuous, $x \in X$. For $V \in \mathcal{N}(f(x))$, there exists $U \in \mathcal{T}(f(x))$ with $U \subset V$; then $f^{-1}(U)$ is open, contains x and is contained in $f^{-1}(V)$; hence $f^{-1}(V) \in \mathcal{N}(x)$. For the converse, assume that f is continuous at all points. Let $U \subset Y$ open; we prove that $f^{-1}(U)$ is open. For each $x \in f^{-1}(U)$, continuity at x implies that $f^{-1}(U)$ is a neighborhood of x , hence we find $U_x \subset f^{-1}(U)$, with U_x -open containing x . It follows that $f^{-1}(U)$ is the union of all U_x with $x \in f^{-1}(U)$, hence it must be open. \square

Neighborhoods also allow us to talk about convergence.

DEFINITION 2.26. Given a sequence $(x_n)_{n \geq 1}$ of elements of in a topological space (X, \mathcal{T}_X) , $x \in X$, we say that $(x_n)_{n \geq 1}$ converges to x in (X, \mathcal{T}) , and we write $x_n \rightarrow X$ (or $\lim_{n \rightarrow \infty} x_n = x$) if for each $V \in \mathcal{N}_x$, there exists an integer n_V such that

$$(3.3) \quad x_n \in V \quad \forall n \geq n_V.$$

EXAMPLE 2.27. Let X be a set. Then, in $(X, \mathcal{T}_{\text{triv}})$, any sequence $(x_n)_{n \geq 1}$ of points in X converges to any $x \in X$. In contrast, in $(X, \mathcal{T}_{\text{dis}})$, a sequence $(x_n)_{n \geq 1}$ converges to an $x \in X$ if and only if $(x_n)_{n \geq 1}$ is stationary equal to x , i.e. there exists n_0 such that $x_n = x$ for all $n \geq n_0$.

To clarify the relationship between convergence and continuity, we introduce:

DEFINITION 2.28. Let (X, \mathcal{T}_X) , (Y, \mathcal{T}_Y) be topological spaces, $f : X \rightarrow Y$. We say that f is sequentially continuous if, for any sequence $(x_n)_{n \geq 1}$ in X , $x \in X$, we have:

$$x_n \rightarrow x \text{ in } (X, \mathcal{T}_X) \implies f(x_n) \rightarrow f(x) \text{ in } (Y, \mathcal{T}_Y).$$

THEOREM 2.29. Any continuous function is sequentially continuous.

PROOF. Assume that $x_n \rightarrow x$ (in (X, \mathcal{T}_X)). To show that $f(x_n) \rightarrow f(x)$ (in (Y, \mathcal{T}_Y)), let $V \in \mathcal{N}(f(x))$ arbitrary and we have to find n_V such that $f(x_n) \in V$ for all $n \geq n_V$. Since f is continuous, we must have $f^{-1}(V) \in \mathcal{N}(x)$; since $x_n \rightarrow x$, we find n_V such that $x_n \in f^{-1}(V)$ for all $n \geq n_V$. Clearly, this n_V has the desired properties. \square

DEFINITION 2.30. Let (X, \mathcal{T}) be a topological space and $x \in X$. A basis of neighborhoods of x (in the topological space (X, \mathcal{T})) is a collection \mathcal{B}_x of neighborhoods of x with the property that

$$\forall V \in \mathcal{T}(x) \exists B \in \mathcal{B}_x : B \subset V.$$

EXAMPLE 2.31. If (X, d) is a metric space, $x \in X$, the family of all balls centered at x ,

$$(3.4) \quad \mathcal{B}_d(x) := \{B(x; \epsilon) : \epsilon > 0\},$$

is a basis of neighborhoods of x .

REMARK 2.32. What are bases of neighborhoods good for? They are collections of neighborhoods which are “rich enough” to encode the local topology around the point. I.e., instead of proving conditions for all $V \in \mathcal{N}(x)$, it is enough to do it only for the elements of a basis. For instance, in the the definition of convergence $x_n \rightarrow x$ (Definition 2.26), if we have a basis \mathcal{B}_x of neighborhoods of x , it suffices to check the condition from the definition only for neighborhoods $V \in \mathcal{B}_x$ (why?). In the case of a metric space (X, d) , we recover the more familiar description of convergence: using the basis (3.4) we find that $x_n \rightarrow x$ if and only if:

$$\forall \epsilon > 0, \exists n_\epsilon \in \mathbb{N} : d(x_n, x) < \epsilon \quad \forall n \geq n_\epsilon.$$

A similar discussion applies to the notion of continuity at a point- Definition 2.24: if we have a basis $\mathcal{B}_{f(x)}$ of neighborhoods of $f(x)$, then it suffices to check (3.2) for all $V \in \mathcal{B}_{f(x)}$. As before, if f is a map between two metric spaces (X, d_X) and (Y, d_Y) , we find the more familiar description of continuity: using the basis (3.4) (with x replaced by $f(x)$), and using (3.1), we find that f is continuous at x if and only if, for all $\epsilon > 0$, there exists $\delta > 0$ such that

$$d_Y(f(y), f(x)) < \epsilon \quad \forall y \in X \text{ satisfying } d_X(y, x) < \delta.$$

DEFINITION 2.33. We say that (X, \mathcal{T}) satisfies the first countability axiom, or that it is 1st-countable, if for each point $x \in X$ there exists a countable basis of neighborhoods of x .

EXERCISE 2.7. Show that the first-countability is a topological property.

EXAMPLE 2.34. Any metric space (X, d) is 1st countable: for $x \in X$,

$$\mathcal{B}'_d(x) := \{B(x; \frac{1}{n}) : n \in \mathbb{N}\}$$

is a countable basis of neighborhoods of x . Hence, in relation with the metrizable problem, we deduce: if a topological space is metrizable, then it must be 1st countable.

EXERCISE 2.8. Let (X, \mathcal{T}) be a topological space and $x \in X$. Show that if x admits a countable basis of neighborhoods, then one can also find a decreasing one, i.e. one of type

$$\mathcal{B}_x = \{B_1, B_2, B_3, \dots\}, \text{ with } \dots \subset B_3 \subset B_2 \subset B_1.$$

(Hint: $B_n = V_1 \cap V_2 \cap \dots \cap V_n$).

The role of the first countability axiom is a theoretical one: “it is the axiom under which the notion of sequence can be used in its full power”. For instance, Theorem 2.29 can be improved:

THEOREM 2.35. If X is 1st countable (in particular, if X is a metric space) then a map $f : X \rightarrow Y$ is continuous if and only if it is sequentially continuous.

PROOF. We are left with the converse implication. Assume f -continuous. By Prop. 2.25, we find $x \in X$ such that f is not continuous at x . Hence we find $V \in \mathcal{N}(f(x))$ such that $f^{-1}(V) \notin \mathcal{N}(x)$. Let $\{B_n : n \in \mathbb{N}\}$ be a countable basis of neighborhoods of x ; by the previous exercise, we may assume it is decreasing. Since $f^{-1}(V) \notin \mathcal{N}(x)$, for each n we find $x_n \in B_n - f^{-1}(V)$. Since $x_n \in B_n$, it follows that $(x_n)_{n \geq 1}$ converges to x (see Remark 2.32). But note that $(f(x_n))$ cannot converge to $f(x)$ since $f(x_n) \notin V$ for all n . This contradicts the hypothesis. \square

Another good illustration of the fact that, under the first-countability axiom, “convergent sequences contain all the information about the topology”, is given in Exercise 2.43. Another illustration is the characterisation of Hausdorffness (Theorem 2.46 below).

4. Inside a topological space: closure, interior and boundary

DEFINITION 2.36. Let (X, \mathcal{T}) be a topological space. Given $A \subset X$, define:

- the interior of A :

$$\overset{\circ}{A} = \bigcup_{U \text{--open contained in } A} U.$$

(The union is over all the subsets U of A which are open in (X, \mathcal{T})). It is sometimes denoted by $\text{Int}(A)$. Note that $\overset{\circ}{A}$ is open, is contained in A , and it is the largest set with these properties.

- the closure of A :

$$\bar{A} = \bigcap_{F \text{--closed containing } A} F.$$

(The intersection is over all the subsets F of X which contain A and are closed in (X, \mathcal{T})). It is sometimes denoted by $\text{Cl}(A)$. Note that \bar{A} is closed, contains A , and it is the smallest set with these properties.

- the boundary of A :

$$\partial(A) = \bar{A} - \overset{\circ}{A}.$$

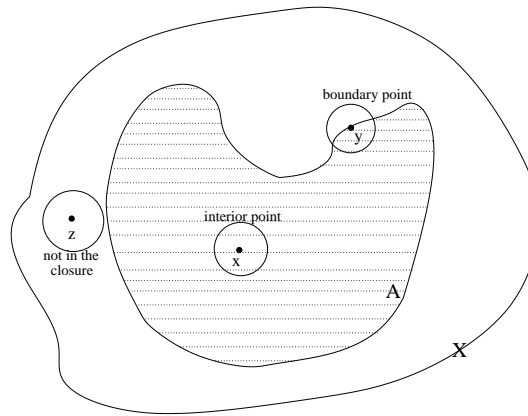

FIGURE 1.

LEMMA 2.37. Let (X, \mathcal{T}) be a topological space, $x \in X$, and assume that \mathcal{B}_x is a basis of neighborhoods around x (e.g. $\mathcal{B}_x = \mathcal{T}(x)$). Then:

- $x \in \overset{\circ}{A}$ if and only if there exists $U \in \mathcal{B}_x$ such that $U \subset A$.
- $x \in \bar{A}$ if and only if, for all $U \in \mathcal{B}_x$, $U \cap A \neq \emptyset$.
- If (X, \mathcal{T}) is metrizable (or just 1st countable) then $x \in \bar{A}$ if and only if there exists a sequence $(a_n)_{n \geq 1}$ of elements of A such that $a_n \rightarrow x$.

See Figure 1.

PROOF. (of the lemma) You should first convince yourself that (i) is easy; we prove here (ii) and (iii). To prove the equivalence in (ii), is sufficient to prove the equivalence of the negations, i.e.

$$[x \notin \bar{A}] \iff [\exists U \in \mathcal{B}_x : U \cap A = \emptyset].$$

From the definition of \overline{A} , the left hand side is equivalent to:

$$\exists F - \text{closed} : A \subset F, x \notin F.$$

Since closed sets are those of type $F = X - U$ with U -open, this is equivalent to

$$\exists U - \text{open} : A \cap U = \emptyset, x \in U,$$

i.e.: there exists $U \in \mathcal{T}(x)$ such that $U \cap A = \emptyset$. On the other hand, any $U \in \mathcal{T}(x)$ contains at least one $B \in \mathcal{B}_x$, and the condition $U \cap A = \emptyset$ will not be destroyed if we replace U by B . This concludes the proof of (ii). For (iii), first assume that $x = \lim a_n$ for some sequence of elements of A . Then, for any $U \in \mathcal{T}(x)$, we find n_U such that $a_n \in U$ for all $n \geq n_U$, which shows that $U \cap A \neq \emptyset$. By (ii), $x \in \overline{A}$. For the converse, one uses that fact that $B(x, \frac{1}{n}) \cap A \neq \emptyset$ hence, for each n , we find $a_n \in A$ with $d(a_n, x) < \frac{1}{n}$. Clearly $a_n \rightarrow x$. \square

EXAMPLE 2.38. Take the “open disk” in the plane

$$A = \overset{\circ}{D}^2 (= \{(x, y) \in \mathbb{R}^2 : x^2 + y^2 < 1\}).$$

Then the interior of A is A itself (it is open!), the closure is the “closed disk”

$$A = D^2 (= \{(x, y) \in \mathbb{R}^2 : x^2 + y^2 \leq 1\}),$$

while the boundary is the unit circle

$$\partial(A) = S^1 (= \{(x, y) \in \mathbb{R}^2 : x^2 + y^2 = 1\}).$$

EXAMPLE 2.39. Take $A = [0, 1) \cup \{2\} \cup [3, 4)$ in $X = \mathbb{R}$. Using the lemma (and the basis given by open intervals) we find

$$\overset{\circ}{A} = (0, 1) \cup (3, 4), \quad \overline{A} = [0, 1] \cup \{2\} \cup [3, 4], \quad \partial(A) = \{0, 1, 2, 3, 4\}.$$

However, considering A inside $X' = [0, 4)$ (with the topology induced from \mathbb{R}),

$$\overset{\circ}{A} = [0, 1) \cup (3, 4), \quad \overline{A} = [0, 1] \cup \{2\} \cup [3, 4), \quad \partial(A) = \{1, 2, 3\}.$$

For the case of metric spaces, let us point out the following corollary. To state it, recall that given a metric space (X, d) , $A \subset X$, and $x \in X$, one defines the distance between x and A as

$$d(x, A) = \inf\{d(x, a) : a \in A\}.$$

COROLLARY 2.40. *If A is a subspace of a metric space (X, d) , $x \in X$, then the following are equivalent:*

- (1) $x \in \overline{A}$.
- (2) there exists a sequence (a_n) of elements of A such that $a_n \rightarrow x$.
- (3) $d(x, A) = 0$.

PROOF. The equivalence of (1) and (2) follows directly from (iii) of the lemma. Next, the condition (3) means that, for all $\epsilon > 0$, there exists $a \in A$ such that $d(x, a) < \epsilon$. In other words, $A \cap B(x, \epsilon) \neq \emptyset$ for all $\epsilon > 0$. Using (iii) of the lemma (with \mathcal{B}_x being the collection of all balls centered at x), we find that (3) is equivalent to (1). \square

DEFINITION 2.41. *Given a topological space X , a subset $A \subset X$ is called dense in X if $\overline{A} = X$.*

EXAMPLE 2.42. $\overset{\circ}{D}^n$ is dense in D^n ; \mathbb{Q} is dense in \mathbb{R} .

5. Hausdorffness; 2nd countability; topological manifolds

One of the powers of the notion of topological space comes from its generality, which gives it a great flexibility when it comes to examples and general constructions. However, in many respects the definition is “too general”. For instance, for proving interesting results one often has to impose extra-axioms. Sometimes these axioms are rather strong (e.g. compactness), but sometimes they are rather weak (in the sense that most of the interesting examples satisfy them anyway). The most important such (weak) axiom is “Hausdorffness”. This axiom is also important for the metrization problem, for which we have to understand the special topological properties that a topology must satisfy in order to be induced by a metric. And Hausdorffness is the most basic one.

DEFINITION 2.43. *We say that a topological space (X, \mathcal{T}) is Hausdorff if for any $x, y \in X$ with $x \neq y$, there exist $V \in \mathcal{N}(x)$ and $W \in \mathcal{N}(y)$ such that $V \cap W = \emptyset$.*

EXAMPLE 2.44. Looking at the extreme topologies: $\mathcal{T}_{\text{triv}}$ is not Hausdorff (unless X is empty or consists of one point only), while \mathcal{T}_{dis} is Hausdorff. In the light of the Hausdorffness property, the cofinal topology \mathcal{T}_{cf} becomes more interesting (see Exercise 2.62).

EXERCISE 2.9. Show that Hausdorffness is a topological property.

As promised, one has:

PROPOSITION 2.45. *Any metric space is Hausdorff.*

PROOF. Given (X, d) , $x, y \in X$ distinct, we must have $r := d(x, y) > 0$. We then choose $V = B(x; \frac{r}{2})$, $W = B(y; \frac{r}{2})$. We claim these are disjoint. If not, we find z in their intersection, i.e. $z \in X$ such that $d(x, z)$ and $d(y, z)$ are both less than $\frac{r}{2}$. From the triangle inequality for d we obtain the following contradiction

$$r = d(x, y) < d(x, z) + d(z, y) < \frac{r}{2} + \frac{r}{2} = r.$$

□

However, one of the main reasons that Hausdorffness is often imposed comes from the fact that, under it, sequences behave “as expected”.

THEOREM 2.46. *Let (X, \mathcal{T}) be a topological space. If X is Hausdorff, then every sequence $(x_n)_{n \geq 1}$ has at most one limit in X . The converse holds if we assume that (X, \mathcal{T}) is 1st countable.*

PROOF. Assume that X is Hausdorff. Assume that there exists a sequence $(x_n)_{n \geq 1}$ in X converging both to $x \in X$ and $y \in X$, with $x \neq y$; the aim is to reach a contradiction. Choose $V \in \mathcal{N}(x)$ and $W \in \mathcal{N}(y)$ such that $V \cap W = \emptyset$. Then we find n_V and n_W such that $x_n \in V$ for all $n \geq n_V$, and similarly for W . Choosing $n > \max\{n_V, n_W\}$, this will contradict the fact that V and W are disjoint.

Let’s now assume that X is 1st countable and each sequence in X has at most one limit, and we prove that X is Hausdorff. Assume it is not. We find then $x \neq y$ two elements of X such that $V \cap W \neq \emptyset$ for all $V \in \mathcal{N}(x)$ and $W \in \mathcal{N}(y)$. Choose $\{V_n : n \geq 1\}$ and $\{W_n : n \geq 1\}$ bases of neighborhoods of x and y , which we may assume to be decreasing (cf. Exercise 2.8). For each n , we find an element $x_n \in V_n \cap W_n$. As in the previous proofs, this implies that x_n converges both to x and to y which contradicts the hypothesis. □

Besides Hausdorffness, there is another important axiom that one often imposes on the spaces one deals with (especially on the spaces that arise in Geometry).

DEFINITION 2.47. Let (X, \mathcal{T}) be a topological space. A basis of the topological space (X, \mathcal{T}) is a family \mathcal{B} of opens of X with the property that any open $U \subset X$ can be written as a union of opens that belong to \mathcal{B} .

We say that (X, \mathcal{T}) satisfies the second countability axiom, or that it is second-countable (also written 2nd countable) if it admits a countable basis.

EXERCISE 2.10. Given a topological space (X, \mathcal{T}) and a family \mathcal{B} of opens of X , show that \mathcal{B} is a basis of (X, \mathcal{T}) if and only if, for each $x \in X$,

$$\mathcal{B}_x := \{B \in \mathcal{B} : x \in B\}$$

is a basis of neighborhoods of x . Deduce that any 2nd countable space is also 1st countable.

EXAMPLE 2.48. In a metric space (X, d) , the collection of all balls

$$\mathcal{B}_d := \{B(x, r) : x \in X, r > 0\}$$

is a basis for the topology \mathcal{T}_d (see the end of the proof of Proposition 2.4). Although metric spaces are always 1st countable (cf. Example 2.34), not all are 2nd countable. However:

EXAMPLE 2.49. For \mathbb{R}^n , one can restrict to balls centered at points with rational coordinates:

$$\mathcal{B}_{\text{Eucl}}^{\mathbb{Q}} := \{B(x, \frac{1}{k}) : x \in \mathbb{Q}^n, k \in \mathbb{Q}_+\}.$$

This is a countable family since \mathbb{Q} is countable and products of countable sets are countable.

EXERCISE 2.11. Show that $\mathcal{B}_{\text{Eucl}}^{\mathbb{Q}}$ is a basis of \mathbb{R}^n . Deduce that any $A \subset \mathbb{R}^n$ is 2nd countable.

Finally, we come at the notion of topological manifold.

DEFINITION 2.50. An n -dimensional topological manifold is any Hausdorff, 2nd countable topological space X which has the following property: any point $x \in X$ admits an open neighborhood U which is homeomorphic to \mathbb{R}^n .

REMARK 2.51. Of course, the most important condition is the one requiring X to be locally homeomorphic to \mathbb{R}^n . A pair (U, χ) consisting of an open $U \subset X$ and a homeomorphism

$$\chi : U \rightarrow \mathbb{R}^n, \quad x \mapsto \chi(x) = (\chi_1(x), \dots, \chi_n(x))$$

is called a (local) coordinate chart for X ; U is called the domain of the chart; $\chi_1(x), \dots, \chi_n(x)$ are called the coordinates of x in the chart (U, χ) . Given another chart $\psi : V \rightarrow \mathbb{R}^n$,

$$c := \psi \circ \chi^{-1} : \chi(U \cap V) \rightarrow \psi(U \cap V)$$

(a homeomorphism between two opens in \mathbb{R}^n) is called the change of coordinates from χ to ψ (it satisfies $\psi_i(x) = c_i(\chi_1(x), \dots, \chi_n(x))$ for all $x \in X$). By definition, topological manifolds can be covered by (domains of) coordinate charts; hence they can be thought of as obtained by “patching together” several copies of \mathbb{R}^n , glued according to the change of coordinates.

REMARK 2.52. One may wonder why the “2nd countability” condition is imposed. Well, there are many reasons. The simplest one: we do hope that a topological manifold can be embedded in some \mathbb{R}^N for N large enough. However, as the previous exercise shows, this would imply that X must be 2nd countable anyway. Also, the 2nd countability condition implies that X can be covered by a countable family of coordinate charts (see Exercise 2.63).

EXAMPLE 2.53. Of course, \mathbb{R}^n is itself a topological manifold. Using the stereographic projection (see the previous chapter), we see that the spheres S^n are topological n -manifolds. But note that, while the open disks are topological manifolds, the closed disks are not.

EXERCISE 2.12. Show that the torus is a 2-dimensional topological manifold. What about the Klein bottle? What about the Moebius band? Try to define “manifolds with boundary”.

6. More on separation

The Hausdorffness is just one of the possible “separation axioms” that one may impose (the most important one!). Such separation axioms are relevant to the metrization problem, as they are automatically satisfied by metric spaces. Here is the precise definition.

DEFINITION 2.54. *We say that two subspaces A and B of a topological space (X, \mathcal{T}) can be separated topologically (or simply separated) if there are open sets U and V such that*

$$A \subset U, B \subset V, \text{ and } U \cap V = \emptyset.$$

We say that A and B can be separated by continuous functions if there exists a continuous function $f : X \rightarrow [0, 1]$ such that $f|_A = 0$, $f|_B = 1$ (and we say that f separates A and B).

EXAMPLE 2.55. If A and B can be separated by continuous functions, then they can be separated topologically as well. Indeed, if f separates A and B , then

$$U = f^{-1}\left(\left(-\infty, \frac{1}{2}\right)\right), V = f^{-1}\left(\left(\frac{1}{2}, \infty\right)\right)$$

are disjoint opens (as pre-images of opens by a continuous map) containing A and B .

The separation conditions are most natural when A and B are closed in X . For instance, inside \mathbb{R} , $[0, 1)$ and $(1, 2]$ cannot be separated by continuous functions, while $[0, 1)$ and $[1, 2]$ cannot be separated even topologically (see also Exercise 2.64).

In any metric space (X, d) , any two disjoint closed subsets A and B can be separated: indeed,

$$U = \{x \in X : d(x, A) < d(x, B)\}, V = \{x \in X : d(x, A) > d(x, B)\}$$

are disjoint opens containing A and B . Here we use the continuity of the function $d_A : X \rightarrow \mathbb{R}$, $x \mapsto d(x, A)$ (see Exercise 2.32) and the similar function d_B . Actually, one can separate A and B even by continuous functions: take

$$f : X \rightarrow [0, 1], \quad f(x) = \frac{d_A(x)}{d_A(x) + d_B(x)}.$$

There are several classes of separation conditions one may impose on a topological space X . At one extreme, when the separation is required for sets of one elements, we talk about the Hausdorffness condition. At the other extreme, one has “normality”:

DEFINITION 2.56. *A topological space is called normal if it is Hausdorff and any two disjoint closed subsets can be separated topologically.*

From our previous discussion it follows that all metrizable spaces are normal. As we shall see, for normal spaces disjoint closed subsets can always be separated by continuous functions (Urysohn lemma) and 2nd countable normal spaces are metrizable (Urysohn metrization theorem). That is why normal spaces are important. However, one should be aware that “normality” is a condition that is (so) important mainly inside the field of Topology; as soon as one moves to neighbouring fields (Geometry, Analysis, etc), although many of the topological spaces one meets there are normal, very little attention is paid to this condition (and you will almost never hear about “normal spaces” in other courses). For instance, in such fields, Urysohn lemma (so important for Topology), often follows by simple tricks (e.g., as many such spaces are already metrizable, it follows from the previous remark). For that reason we decided not to concentrate too much on normal spaces; also, although the proof of Urysohn’s results could be presented right away, we have decided not to do them until they are absolutely needed. Note that, in contrast with “normality”, the other topological conditions that we will study, such as Hausdorffness, connectedness, compactness, local compactness and even paracompactness, show up all over in mathematics whenever topological spaces are relevant, and they are indispensable.

7. More exercises

7.1. On topologies.

EXERCISE 2.13. How many distinct topologies can there be defined on a set with two elements? But with three?

EXERCISE 2.14. Consider the set $\bar{\mathbb{N}} := \mathbb{N} \cup \{\infty\}$ (the set of strictly positive integers to which we add the infinity) and, for each $n \in \mathbb{N}$ put

$$U_n := \{k \in \bar{\mathbb{N}} : k \geq n\} = \{n, n+1, \dots\} \cup \{\infty\}.$$

Show that the following is a topology on $\bar{\mathbb{N}}$:

$$\mathcal{T}_{\text{seq}} := \{\emptyset, U_1, U_2, U_3, \dots\}.$$

EXERCISE 2.15. Prove that, for any set X , \mathcal{T}_{cf} and \mathcal{T}_{cc} are indeed topologies.

EXERCISE 2.16. On \mathbb{R} consider the family \mathcal{T} consisting of \emptyset , \mathbb{R} and all intervals of type $(-\infty, r)$ with $r \in \mathbb{R}$. Show that \mathcal{T} is a topology on \mathbb{R} and compare it with the Euclidean topology.

EXERCISE 2.17. On \mathbb{R} consider the family \mathcal{B} consisting of \emptyset , \mathbb{R} and all intervals of type $(-\infty, r]$ with $r \in \mathbb{R}$. Show that \mathcal{B} is not a topology on \mathbb{R} and find the smallest topology containing \mathcal{B} . Is it larger or smaller than the topology from the previous exercise? But than the Euclidean topology?

EXERCISE 2.18. Let \mathcal{T} be a topology on \mathbb{R} . Show that \mathcal{T} is the discrete topology if and only if $\{r\} \in \mathcal{T}$ for all $r \in \mathbb{R}$.

EXERCISE 2.19. Let \mathcal{T}_l be the smallest topology on \mathbb{R} which contains all the intervals of type $[a, b)$ with $a, b \in \mathbb{R}$. Similarly, define \mathcal{T}_r using intervals of type $(a, b]$. Show that:

1. A subset $D \subset \mathbb{R}$ belongs to \mathcal{T}_l if and only if the following condition holds: for any $x \in D$ there exists an interval $[a, b)$ such that

$$x \in [a, b) \subset D.$$

2. \mathcal{T}_l and \mathcal{T}_r are finer than $\mathcal{T}_{\text{eucl}}$, but \mathcal{T}_l and \mathcal{T}_r are not comparable.
3. \mathcal{T}_{dis} is the only topology on \mathbb{R} which contains both \mathcal{T}_l and \mathcal{T}_r .

EXERCISE 2.20. Consider a set X , a set of indices I and, for each $i \in I$, a topology \mathcal{T}_i on X . Show that $\mathcal{T} := \bigcap_i \mathcal{T}_i$ (i.e. the family consisting of subsets $U \subset X$ with the property that $U \in \mathcal{T}_i$ for all $i \in I$) is a topology on X .

EXERCISE 2.21. Given a set X and a family \mathcal{S} of subsets of X , prove that there exists a topology $\mathcal{T}(\mathcal{S})$ on X which contains \mathcal{S} and is the smallest with this property. (Hint: use the axioms to see what other subsets of X , besides the ones from \mathcal{S} , must $\mathcal{T}(\mathcal{S})$ contain.)

EXERCISE 2.22. On \mathbb{R}^2 we define the topology $\mathcal{T}_l \times \mathcal{T}_l$ as the smallest topology which contains all subsets of type

$$[a, b) \times [c, d)$$

with $a, b, c, d \in \mathbb{R}$. Define similarly $\mathcal{T}_r \times \mathcal{T}_r$, $\mathcal{T}_l \times \mathcal{T}_r$ and $\mathcal{T}_r \times \mathcal{T}_l$. Show that any two of these four topologies are not comparable.

EXERCISE 2.23. To remove ambiguities regarding the Convention 2.9 show that, inside any topological space (X, \mathcal{T}) , for all $A \subset Y \subset X$ one has

$$(\mathcal{T}|_Y)|_A = \mathcal{T}|_A.$$

To remove ambiguities regarding Convention 2.7 and 2.9 show that, for $A \subset \mathbb{R}^n$, the Euclidean topology on A coincides with the restriction to A of the Euclidean topology of \mathbb{R}^n .

EXERCISE 2.24. Let (X, d) be a metric space, A, B subspaces of X such that

$$d(A, B) = 0.$$

(where $d(A, B) := \inf\{d(a, b) : a \in A, b \in B\}$).

Is it true that A and B must have a common point (i.e. $A \cap B \neq \emptyset$)? What if we assume that both A and B are closed?

7.2. On induced topologies.

EXERCISE 2.25. Consider the real line \mathbb{R} as a subset of the plane \mathbb{R}^2 . Show that the induced topology on \mathbb{R} coincides with the Euclidean topology on the real line.

EXERCISE 2.26. Find an example of a topological space X and $A \subset B \subset X$ such that A is closed in B , B is open in X , and A is neither open nor closed in X .

EXERCISE 2.27. Which of the following subsets of the plane are open?

1. $A = \{(x, y) : x \geq 0\}$.
2. $B = \{(x, y) : x = 0\}$.
3. $C = \{(x, y) : x > 0, y < 5\}$.
4. $D = \{(x, y) : xy < 1, x \geq 0\}$.
5. $E = \{(x, y) : 0 \leq x < 5\}$.

Note that all these sets are contained in A . Which ones are open in A ?

EXERCISE 2.28. Let (X, \mathcal{T}) be a topological space and $B \subset A \subset X$.

1. If A is open in X , show that B is open in X if and only if it is open in A .
2. If A is closed in X , show that B is closed in X if and only if it is closed in A .

EXERCISE 2.29. Given a topological space (X, \mathcal{T}) and $A \subset X$, show that the induced topology $\mathcal{T}|_A$ is the smallest topology on A with the property that the inclusion map $i : A \rightarrow X$ is continuous.

7.3. On continuity.

EXERCISE 2.30. Consider

$$D := \{(x, y) : e^x > \sin(y)\cos(x)\},$$

$$A := \{(x, y) : x^7 - \sin(y^7) \geq \frac{1}{x^2 + y^2 + 1}\}.$$

Show that D is open in \mathbb{R}^2 , while A is closed in \mathbb{R}^2 .

EXERCISE 2.31. Let \mathbb{R} be endowed with the topology \mathcal{T}_l from Exercise 2.19. Which one of the following functions $f : \mathbb{R} \rightarrow \mathbb{R}$ is continuous:

- (i) $f(x) = x + 1$
- (ii) $f(x) = -x$.
- (iii) $f(x) = x^2$.

EXERCISE 2.32. If (X, d) is a metric space and A is a subspace of X , then the function

$$d_A : X \rightarrow \mathbb{R}, \quad d_A(x) = d(x, A)$$

is continuous.

Deduce that, for any closed subset A of a metric space X , there exists a continuous function $f : X \rightarrow [0, 1]$ such that $A = f^{-1}(0)$.

EXERCISE 2.33. The space $M_n(\mathbb{R})$, of $n \times n$ matrices with real coefficients can be identified with \mathbb{R}^{n^2} and in this way has a natural topology (coming from the Euclidean metric). Prove that:

1. the subspace $GL_n(\mathbb{R})$ of invertible matrices is open in $M_n(\mathbb{R})$.
2. the subspace $SL_n(\mathbb{R})$ consisting of invertible matrices of determinant equal to 1 is closed in $GL_n(\mathbb{R})$.
3. the subspace

$$O(n) := \{A \in GL_n(\mathbb{R}^n) : AA^* = \text{Id}\}$$

is also closed (where A^* denotes the transpose of A and Id is the identity matrix).

EXERCISE 2.34. Let X and Y be two topological spaces, $f : X \rightarrow Y$. We say that f is continuous at a point $x \in X$ if, for any neighborhood V of $f(x)$ in Y there exists a neighborhood U of x in X such that $f(U) \subset V$. Show that f is continuous if and only if it is continuous at all points $x \in X$.

7.4. On homeomorphisms and embeddings.

EXERCISE 2.35. Show that the following three spaces are homeomorphic (giving the explicit homeomorphisms):

$$X = \{(x, y) \in \mathbb{R}^2 : 0 < x^2 + y^2 \leq 1\} \subset \mathbb{R}^2$$

$$Y = \{(x, y) \in \mathbb{R}^2 : \frac{1}{2} < x^2 + y^2 \leq 1\} \subset \mathbb{R}^2$$

$$Z = S^1 \times (0, 1] = \{(x, y, z) \in \mathbb{R}^3 : x^2 + y^2 = 1, 0 < z \leq 1\} \subset \mathbb{R}^3.$$

Then compute the interiors and the boundaries of X , Y (in \mathbb{R}^2) and Z (in \mathbb{R}^3). How comes that, although X , Y and Z are homeomorphic, their interiors and boundaries are quite different?

EXERCISE 2.36. From the topologies that you found in Exercise 2.13, how many non homeomorphic ones are there?

EXERCISE 2.37. Show that \mathbb{R} endowed with the Euclidean topology is not homeomorphic to \mathbb{R} endowed with the topology from Exercise 2.16.

EXERCISE 2.38. Exhibit an embedding $f : M \rightarrow M$ of the Moebius band into itself which is not surjective. What is the boundary of $f(M)$ in M ?

7.5. The “removing a point trick”. The first part of the following exercise is extremely useful for some of the later exercises.

EXERCISE 2.39. If X and Y are homeomorphic, prove that for any $x \in X$ there exists $y \in Y$ such that $X - \{x\}$ is homeomorphic to $Y - \{y\}$.

Also explain that, “there exists $y \in Y$ ” cannot be replaced with “for any $y \in Y$ ”.

7.6. On convergence.

EXERCISE 2.40. Let $X = (0, 1)$ endowed with the Euclidean topology. Is the sequence

$$x_n = \frac{1}{n}$$

convergent in the topological space X ?

EXERCISE 2.41. Let \mathbb{R} be endowed with the topology \mathcal{T}_l from Exercise 2.19. Study the convergence of the sequences $(x_n)_{n \geq 1}$ and $(y_n)_{n \geq 1}$ where

$$x_n = \frac{1}{n}, \quad y_n = -\frac{1}{n}.$$

EXERCISE 2.42. What about convergence in (X, \mathcal{T}_{cf}) . But about (X, \mathcal{T}_{cc}) ?

EXERCISE 2.43. We say that two topologies \mathcal{T}_1 and \mathcal{T}_2 on X have the same convergence of sequences if, for a sequence $(x_n)_{n \geq 1}$ of elements of X , and $x \in X$, one has:

$$x_n \xrightarrow{\mathcal{T}_1} x \iff x_n \xrightarrow{\mathcal{T}_2} x.$$

Show that

- If \mathcal{T}_1 and \mathcal{T}_2 satisfy the first countability axiom and have the same convergence of sequences, then $\mathcal{T}_1 = \mathcal{T}_2$.
- This is no longer true if one gives up the first countability axiom.

(Hint for the second part: This is difficult. Try \mathcal{T}_{discr} and \mathcal{T}_{cf} . If it does not work, try to change one of them).

7.7. On closure, interior, etc.

EXERCISE 2.44. Let $X = (-\infty, 1) \cup (1, 4) \cup [5, \infty)$. Find the closure, the interior and the boundary (in X) of $A = [0, 10 \cup (1, 2) \cup [3, 4) \cup (5, 6)$.

EXERCISE 2.45. Find the interior and the closure of \mathbb{Q} in \mathbb{R} in each of the cases: when \mathbb{R} is endowed with

- the Euclidean topology.
- the discrete topology.
- the cofinite topology.
- the co-countable topology.

EXERCISE 2.46. Find the closure, the interior and the boundary of the following subsets of the plane:

1. $\{(x, y) : x \geq 0, y \neq 0\}$.
2. $\{(x, y) : x \in \mathbb{Q}, y > 0\}$.

EXERCISE 2.47. For each of the sets from Exercise 2.27, find the interior, closure and boundary in the plane. Then in A (i.e. as subspaces of A).

EXERCISE 2.48. Let \mathcal{T}_l be the topology from Exercise 2.19. Find the closure and the interior in $(\mathbb{R}, \mathcal{T}_l)$ of each of the intervals

$$[0, 1), (0, 1], (0, 1), [0, 1].$$

EXERCISE 2.49. Let \mathcal{T}_l be the topology from Exercise 2.19.

(i) In the topological space $(\mathbb{R}, \mathcal{T}_l)$, find the closure, the interior and the boundary of

$$A = (0, 1) \cup [2, 3].$$

(ii) Show that $(\mathbb{R}, \mathcal{T}_l)$ and $(\mathbb{R}, \mathcal{T}_{eucl})$ are not homeomorphic.

EXERCISE 2.50. Compute the interior, the closure and the boundary of

$$A = (0, 1] \times [0, 1)$$

in the topological space $X = \mathbb{R}^2$ endowed with the topology $\mathcal{T}_l \times \mathcal{T}_l$ of Exercise 2.22.

EXERCISE 2.51. Show that, in any topological space X , for any subspace $A \subset X$, one has

$$\partial(A) = \partial(X - A).$$

EXERCISE 2.52. Let A, B be two subsets of a topological space X . Recall that $\text{Int}(A) = \overset{\circ}{A}$ denotes the interior of A . Prove that

1. If $A \subset B$ then $\text{Int}(A) \subset \text{Int}(B)$.
2. $\text{Int}(A \cap B) = \text{Int}(A) \cap \text{Int}(B)$.
3. $\text{Int}(A \cup B) \supset \text{Int}(A) \cup \text{Int}(B)$, but the equality may fail.

EXERCISE 2.53. Let A, B and $\{A_i : i \in I\}$ denote subsets of a topological space X , where i runs in a set of indexes I . Prove that

1. If $A \subset B$ then $\overline{A} \subset \overline{B}$.
2. $\overline{A \cup B} = \overline{A} \cup \overline{B}$.
3. If I is finite then $\overline{\cup_i A_i} = \cup_i \overline{A_i}$.
4. In general, when I is infinite, $\overline{\cup_i A_i} \supset \cup_i \overline{A_i}$, but the two may be different.
5. We say that $\{A_i : i \in I\}$ is locally finite if any point $x \in X$ admits a neighborhood V which intersects all but a finite number of A_i s (i.e. such that $\{i \in I : A_i \cap V \neq \emptyset\}$ is finite). Under this assumption, show that $\overline{\cup_i A_i} = \cup_i \overline{A_i}$.

7.8. Density.

EXERCISE 2.54. Show that \mathbb{Q} is dense in \mathbb{R} .

EXERCISE 2.55. Show that $\mathbb{Q} \times \mathbb{Q}$ is dense in \mathbb{R}^2 .

EXERCISE 2.56. Let T be the torus. Describe (on the picture) a continuous injection $f : \mathbb{R} \rightarrow T$ whose image is dense in T . Is f an embedding?

EXERCISE 2.57. Show that $GL_n(\mathbb{R})$ is dense in $M_n(\mathbb{R})$ (see Exercise 2.33).

EXERCISE 2.58. Show that any continuous function $f : \mathbb{R} \rightarrow \mathbb{R}$ with the property that

$$f(x + y) = f(x) + f(y)$$

for all $x, y \in \mathbb{R}$, then f must be linear, i.e. there exists $a \in \mathbb{R}$ such that

$$f(x) = ax \quad \forall x \in \mathbb{R}.$$

(Hint: $a = f(1)$. For what x 's can you prove that $f(x) = ax$? Then use continuity and the fact \mathbb{Q} is dense in \mathbb{R} .)

7.9. On Hausdorffness, 2nd countability, separation.

EXERCISE 2.59. How many from the topologies from Exercise 2.13 are Hausdorff?

EXERCISE 2.60. Is the topology from Exerc. 2.14 Hausdorff? But from 2.16? But from 2.17?

EXERCISE 2.61. Show that, in any Hausdorff space X , all the subspaces with one element (i.e. of type $A = \{x\}$ with $x \in X$) are closed.

EXERCISE 2.62. Given a set X , show that any Hausdorff topology on X contains \mathcal{T}_{cf} . When is \mathcal{T}_{cf} Hausdorff? When does it exist a smallest Hausdorff topology on X (i.e. a Hausdorff topology which is contained in all other Hausdorff topologies on X)?

EXERCISE 2.63. Let X be a 2nd countable space. Show that from any open cover \mathcal{U} of X one can extract a countable subcover. In other words, for any collection $\mathcal{U} = \{U_i : i \in I\}$ consisting of opens in X such that $X = \cup_{i \in I} U_i$, one can find $i_1, i_2, \dots \in I$ such that $X = \cup_k U_{i_k}$.

EXERCISE 2.64. Consider \mathbb{R} with the Euclidean topology. In each of the following cases, decide (and explain!) when A and B can be separated topologically or by continuous functions:

1. $A = [0, 1), B = (1, 2]$.
2. $A = [0, 1), B = [1, 2]$.
3. $A = [0, 1), B = (2, 3]$.

Exercise. Prove that the sphere S^n is an n -dimensional topological manifold. Show that it can be covered by two coordinate charts. Compute the change of coordinates.

CHAPTER 3

Constructions of topological spaces

1. **Constructions of topologies: quotients**
2. **Special classes of quotients I: quotients modulo group actions**
3. **Another example of quotients: the projective space \mathbb{P}^n**
4. **Constructions of topologies: products**
5. **Special classes of quotients II: collapsing a subspace, cones, suspensions**
6. **Constructions of topologies: Bases for topologies**
7. **Constructions of topologies: Generating topologies**
8. **Example: some spaces of functions**
9. **More exercises**

1. Constructions of topologies: quotients

We now discuss another general construction of topologies. Let's start with a surjective map $\pi : X \rightarrow Y$. Typically, (Y, π) is a quotient of X modulo an equivalence relation R on X ("gluing data"). Assume now that X is endowed with a topology \mathcal{T} . Then one defines

$$\pi_*(\mathcal{T}) := \{V \subset Y : \pi^{-1}(V) \in \mathcal{T}\},$$

called the quotient topology on Y induced by π . A surjective map $\pi : (X, \mathcal{T}_X) \rightarrow (Y, \mathcal{T}_Y)$ between two topological spaces is called a topological quotient map if $\mathcal{T}_Y = \pi_*(\mathcal{T}_X)$.

THEOREM 3.1. *$\pi_*(\mathcal{T})$ is indeed a topology on Y . Moreover, it is the largest topology on Y with the property that $\pi : X \rightarrow Y$ becomes continuous.*

PROOF. Axiom (T1) is immediate. For (T2), let $U_i \in \pi_*(\mathcal{T})$ (with $i \in \{1, 2\}$), i.e. subsets of Y satisfying $\pi^{-1}(U_i) \in \mathcal{T}$. Then

$$\pi^{-1}(U_1 \cap U_2) = \pi^{-1}(U_1) \cap \pi^{-1}(U_2)$$

must be in \mathcal{T} , i.e. $U_1 \cap U_2 \in \pi_*(\mathcal{T})$. The axiom (T3) follows similarly, using the fact that $\pi^{-1}(\cup_i U_i) = \cup_i \pi^{-1}(U_i)$. The last part follows from the definition of continuity and of $\pi_*(\mathcal{T})$. \square

The following is a very useful recognition criteria for continuity of maps defined on quotients.

PROPOSITION 3.2. *Let X be a topological space, $\pi : X \rightarrow Y$ a surjection, and let Y be endowed with the quotient topology. Then, for any other topological space Z , a function $f : Y \rightarrow Z$ is continuous if and only if $f \circ \pi : X \rightarrow Z$ is.*

PROOF. $f^{-1}(U)$ is open in Y if and only if $\pi^{-1}(f^{-1}(U)) = (f \circ \pi)^{-1}(U)$ is open in X . \square

There are some variations on the previous discussion, mainly terminological, when we want to emphasize that Y is the quotient modulo an equivalence relation (see Definition 3.3).

DEFINITION 3.3. *Let R be an equivalence relation defined on a topological space (X, \mathcal{T}) . A quotient of (X, \mathcal{T}) modulo R is a pair (Y, π) consisting of a topological space Y and a topological quotient map $\pi : X \rightarrow Y$ with the property that $\pi(x) = \pi(x')$ holds if and only if $(x, x') \in R$.*

If $Y = X/R$ is the abstract quotient, then the resulting topological space $(X/R, \pi_(\mathcal{T}))$ is called the abstract quotient of (X, \mathcal{T}) modulo R .*

With this terminology, the last proposition translates into:

COROLLARY 3.4. *Assume that (Y, π) is a quotient of the topological space X modulo R . Then, for any topological space Z , there is a 1-1 correspondence between*

- (i) *continuous maps $f : Y \rightarrow Z$.*
- (ii) *continuous maps $\tilde{f} : X \rightarrow Z$ such that $\tilde{f}(x) = \tilde{f}(x')$ whenever $(x, x') \in R$.*

This correspondence is characterized by $\tilde{f} = f \circ \pi$.

Finally, we would like to point out one of the notorious problems that arises when considering quotients: Hausdorffness may be destroyed! (this problem does not appear when we consider subspace or product topologies!). Hence extra-care is required when we deal with quotients.

EXERCISE 3.1. Take two copies of the interval $[0, 2]$, say $X = [0, 2] \times \{0\} \cup [0, 2] \times \{1\}$ (in the plane) and glue the points $(t, 0)$ and $(t, 1)$ for each $t \in [0, 2]$, $t \neq 1$. Show that the resulting quotient space Y is not Hausdorff.

2. Examples of quotients: the abstract torus, Moebius band, etc

In the first chapter we discussed the torus, Moebius band, etc intuitively. We can now have a more complete discussion about them, as topological spaces. Let us concentrate, for example, on the torus. Here are some remarks on the discussions from the first chapter:

1. when constructing it by gluing the opposite sides of a square, although the “shape” of the result may be predicted, the actual result (as a subset of \mathbb{R}^3) depends on all the movements we make while gluing. But even the “shape” is not completely clear: we could have performed the same gluing in a “clumsier way” (e.g., for the Moebius band, we could have twisted the piece of paper three times before the actual gluing).

2. when saying “torus”, we would like to think about the intrinsic space itself. The information that this space can be embedded in \mathbb{R}^3 is interesting and nice, but there may be many such embeddings. See Figure 1 for several different looking embeddings. The “shape” reflects the way one embeds the torus into \mathbb{R}^3 , not only the intrinsic torus.

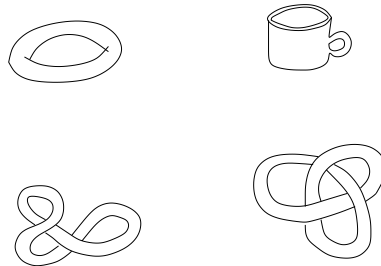

FIGURE 1.

The way to deal with all these in a more precise way is the following:

1. Consider the abstract torus, defined as the abstract quotient

$$T_{\text{abs}} := [0, 1] \times [0, 1]/R,$$

where R is the equivalence relation encoding the gluing. This defines T_{abs} as a topological space.

2. Embed the abstract torus: realizing the torus more concretely in \mathbb{R}^3 , i.e. finding explicit models of it, translates now into the question of describing embeddings

$$f : T_{\text{abs}} \rightarrow \mathbb{R}^3.$$

By Corollary 3.4, continuous f 's correspond to continuous maps

$$\tilde{f} : [0, 1] \times [0, 1] \rightarrow \mathbb{R}^3$$

with the property that $\tilde{f}(t, s) = \tilde{f}(t', s')$ for all $((t, s), (t', s')) \in R$. The injectivity of f is equivalent to the condition that the last equality holds if and only if $((t, s), (t', s')) \in R$.

EXAMPLE 3.5. Such \tilde{f} 's arise in the explicit realizations of the torus (see Chapter 1):

$$\tilde{f}(t, s) = (R + r\cos(2\pi t))\cos(2\pi s), (R + r\cos(2\pi t))\sin(2\pi s), r\sin(2\pi t).$$

The induced f is a continuous injection of T_{abs} into \mathbb{R}^3 whose image is the geometric model $T_{R,r}$ from Section 6. But please note: while we now know that $f : T_{\text{abs}} \rightarrow T_{R,r}$ is a continuous bijection, one still has to show that the inverse is continuous. The best proof of this, which applies immediately to all examples of this type, not only to the torus, and not only to our explicit f , follows from one of the basic properties of compact spaces, which will be discussed in the next chapter.

EXERCISE 3.2. *Fill in the details; do the same for the Moebius band, Klein bottle, \mathbb{P}^2 .*

3. Special classes of quotients I: quotients modulo group actions

In this section we discuss quotients by group actions. Let X be a topological space. We denote by $\text{Homeo}(X)$ the set of all homeomorphisms from X to X . Together with composition of maps, this is a group. Let Γ be another group, whose operation is denoted multiplicatively.

DEFINITION 3.6. An *action* of the group Γ on the topological space X is a group homomorphism

$$\phi : \Gamma \rightarrow \text{Homeo}(X), \quad \gamma \mapsto \phi_\gamma.$$

Hence, for each $\gamma \in \Gamma$, one has a homeomorphism ϕ_γ of X (“the action of γ on X ”), so that

$$\phi_{\gamma\gamma'} = \phi_\gamma \circ \phi_{\gamma'} \quad \forall \gamma, \gamma' \in \Gamma.$$

Sometimes $\phi_\gamma(x)$ is also denoted $\gamma(x)$, or simply $\gamma \cdot x$, and one looks at the action as a map

$$\Gamma \times X \rightarrow X, \quad (\gamma, x) \mapsto \gamma \cdot x.$$

The action induces an equivalence relation R_Γ on X defined by:

$$(x, y) \in R_\Gamma \iff \exists \gamma \in \Gamma \text{ s.t. } y = \gamma \cdot x.$$

The resulting topological quotient is called the quotient of X by the action of Γ , and is denoted by X/Γ . Note that the R_Γ -equivalence class of an element $x \in X$ is precisely its Γ -orbit:

$$\Gamma \cdot x := \{\gamma \cdot x : \gamma \in \Gamma\}.$$

Hence X/Γ consists of all such orbits, and the quotient map sends x to Γx .

EXAMPLE 3.7. The additive group \mathbb{Z} acts on \mathbb{R} by

$$\mathbb{Z} \times \mathbb{R} \rightarrow \mathbb{R}, \quad (n, r) \mapsto \phi_n(r) = n \cdot r := n + r.$$

The resulting quotient is (homeomorphic to) S^1 . More precisely, one uses Corollary 3.4 again to see that the map $\tilde{f} : \mathbb{R} \rightarrow S^1, t \mapsto (\cos(2\pi t), \sin(2\pi t))$ induces a continuous bijection $f : \mathbb{R}/\mathbb{Z} \rightarrow S^1$; then one proves directly (e.g. using sequences) that f is actually a homeomorphism, or one waits again until compactness and its basic properties are discussed.

Here is a fortunate case in which Hausdorffness is preserved when passing to quotients.

THEOREM 3.8. *If X is a Hausdorff space and Γ is a finite group acting on X , then the quotient X/Γ is Hausdorff.*

PROOF. Let $\Gamma x, \Gamma y \in X/\Gamma$ be two distinct points ($x, y \in X$). That they are distinct means that, for each $\gamma \in \Gamma$, $x \neq \gamma y$. Hence, for each $\gamma \in \Gamma$, we find disjoint opens $U_\gamma, V_\gamma \subset X$ containing x , and γy , respectively. Note that

$$W_\gamma = \phi_\gamma^{-1}(V_\gamma)$$

is an open containing y , and what we know is that

$$U_\gamma \cap \phi_\gamma(W_\gamma) = \emptyset.$$

Since Γ is finite, $U := \bigcap_\gamma U_\gamma, V := \bigcap_\gamma W_\gamma$ will be open neighborhoods of x and y , respectively, with the property that

$$U \cap \phi_a(V) = \emptyset, \quad \forall a \in \Gamma.$$

Using the quotient map $\pi : X \rightarrow X/\Gamma$, we consider $\pi(U), \pi(V)$, and we claim that they are disjoint opens in X/Γ separating Γx and Γy . That they are disjoint follows from the previous property of U and V . To see that $\pi(U)$ is open, we have to check that $\pi^{-1}(\pi(U))$ is open, but

$$\pi^{-1}(\pi(U)) = \bigcup_{\gamma \in \Gamma} \phi_\gamma(U)$$

(check this!) is a union of opens, hence opens. Similarly, $\pi(V)$ is open. Clearly, $\Gamma x = \pi(x) \in \pi(U)$ and $\Gamma y = \pi(y) \in \pi(V)$. \square

4. Another example of quotients: the projective space \mathbb{P}^n

A very good illustration of the use of quotient topologies is the construction of the projective space, as a topological space (a set theoretical version of which appeared already in Exercise 1.29).

Recall that, set theoretically, \mathbb{P}^n is the set of all lines through the origin in \mathbb{R}^{n+1} :

$$\mathbb{P}^n = \{l \subset \mathbb{R}^{n+1} : l \text{ one dimensional vector subspace}\}.$$

To realize it as a topological space, we relate it to topological spaces that we already know. There are several ways to handle it.

4.1. As a quotient of $\mathbb{R}^{n+1} - \{0\}$: For this, we use a simple idea: for each point in $\mathbb{R}^{n+1} - \{0\}$ there is (precisely) one line passing through the origin and that point. This translates into the fact that there is a surjective map

$$\pi : \mathbb{R}^{n+1} \rightarrow \mathbb{P}^n, x \mapsto l_x,$$

where l_x is the line through the origin and x :

$$l_x = \mathbb{R}x = \{\lambda x : \lambda \in \mathbb{R}\} \subset \mathbb{R}^{n+1}.$$

The projective space \mathbb{P}^n can now be defined as the set \mathbb{P}^n endowed with the quotient topology. Note also that the equivalence relation underlying π comes from a group action. This is based on the remark that $\pi(x) = \pi(y)$, i.e. $l_x = l_y$, happens if and only if $x = \lambda y$ for some $\lambda \in \mathbb{R}^*$. Hence, taking $\Gamma = \mathbb{R}^*$ (a group with usual multiplication), it acts on $\mathbb{R}^{n+1} - \{0\}$ by:

$$\phi_\lambda(x) = \lambda x \text{ for } \lambda \in \mathbb{R}^*, x \in \mathbb{R}^{n+1} - \{0\}$$

and the projective space becomes

$$\mathbb{P}^n = (\mathbb{R}^{n+1} - \{0\})/\mathbb{R}^*.$$

4.2. As a quotient of S^n : This is based on another simple remark: a line in \mathbb{R}^{n+1} through the origin is uniquely determined by its intersection with the unit sphere $S^n \subset \mathbb{R}^{n+1}$ - which is a set consisting of two antipodal points (the first picture in Figure 2). This indicates that \mathbb{P}^n can be obtained from S^n by identifying (gluing) its antipodal points. Again, this is a quotient that arises from a group action: the group \mathbb{Z}_2 acting on S^n . Using the multiplicative description $\mathbb{Z}_2 = \{1, -1\}$, the action is: ϕ_1 is the identity map, while ϕ_{-1} is the map sending $x \in S^n$ to its antipodal point $-x$. Hence the discussion indicates:

PROPOSITION 3.9. \mathbb{P}^n is homeomorphic to S^n/\mathbb{Z}_2 .

PROOF. The conclusion of the previous discussion is that there is a set-theoretical bijection:

$$\phi : S^n/\mathbb{Z}_2 \rightarrow \mathbb{P}^n,$$

which sends the \mathbb{Z}_2 -orbit of $x \in S^n$ to the line l_x through x , with the inverse

$$\psi : \mathbb{P}^n \rightarrow S^n/\mathbb{Z}_2$$

which sends the line l to $S^n \cap l$ (a \mathbb{Z}_2 -orbit!). We have to check that they are continuous. We use Proposition 3.2 and its corollary. To see that ϕ is continuous, we have to check that the composition with the quotient map $S^n \rightarrow S^n/\mathbb{Z}_2$ is continuous. But this composition is precisely the restriction of the quotient map $\mathbb{R}^{n+1} - \{0\} \rightarrow \mathbb{P}^n$ to S^n , hence is continuous. In conclusion, ϕ is continuous.

To see that ψ is continuous, we have to check that its composition with the quotient map $\mathbb{R}^{n+1} - \{0\} \rightarrow \mathbb{P}^n$ is continuous. But this composition - which is a map from $\mathbb{R}^{n+1} - \{0\}$ to S^n/\mathbb{Z}_2 can be written as the composition of two other maps which we know to be continuous:

- The map $\mathbb{R}^{n+1} - \{0\} \rightarrow S^n$ sending x to $x/\|x\|$.

- The quotient map $S^n \rightarrow S^n/\mathbb{Z}_2$.

In conclusion ψ is continuous. □

COROLLARY 3.10. *The projective space \mathbb{P}^n is Hausdorff.*

4.3. As a quotient of D^n : Again, the starting remark is very simple: the orbits of the action of \mathbb{Z}_2 on S^n always intersect the upper hemisphere S_+^n (for notations, see Section 4 in the first chapter). Moreover, such an orbit either lies entirely in the boundary of S_+^n , or intersects its interior in a unique point. See the second picture in Figure 2. This indicates that \mathbb{P}^n can be obtained from S_+^n by gluing the antipodal points that belong to its boundary. On the other hand, the orthogonal projection onto the horizontal hyperplane defines a homeomorphism between S_+^n and D^n (see Figure 2). Passing to D^n , we obtain an equivalence relation R on D^n given by:

$$(x, y) \in R \iff (x = y) \text{ or } (x, y \in S^{n-1} \text{ and } x = -y),$$

and we have done a part of the following:

EXERCISE 3.3. Show that \mathbb{P}^n is homeomorphic to D^n/R . What happens when $n = 1$?

COROLLARY 3.11. \mathbb{P}^n for $n = 2$ is homeomorphic to the projective plane as defined in Chapter 1 (Section 8), i.e. obtained from the square by gluing the opposite sides as indicated in Figure 3.

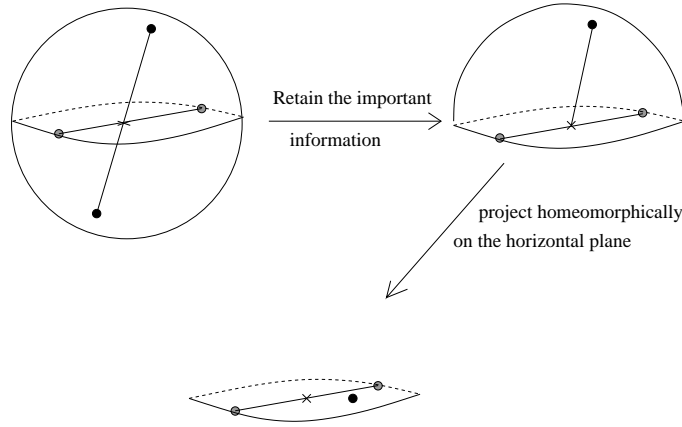

Different ways to encode the lines in the space

FIGURE 2.

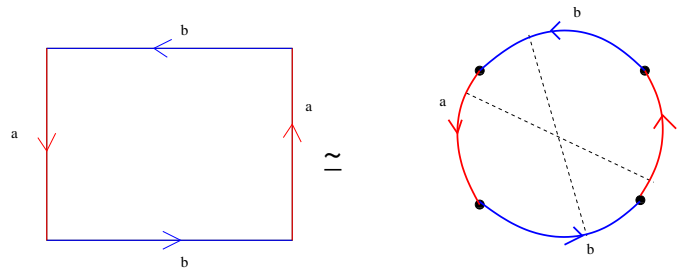

FIGURE 3.

5. Constructions of topologies: products

In this section we explain how the Cartesian product of two topological spaces is naturally a topological space itself. Given two sets X and Y we consider their Cartesian product

$$X \times Y = \{(x, y) : x \in X, y \in Y\}.$$

Given a topology \mathcal{T}_X on X and a topology \mathcal{T}_Y on Y , one defines a topology on $X \times Y$, the “product topology” $\mathcal{T}_X \times \mathcal{T}_Y$, as follows. We say that a subset $D \subset X \times Y$ is open if and only if

$$(5.1) \quad \forall (x, y) \in D \exists U \in \mathcal{T}_X, V \in \mathcal{T}_Y \text{ such that } x \in U, y \in V, U \times V \subset D.$$

We denote by $\mathcal{T}_X \times \mathcal{T}_Y$ the collection of all such D ’s and we call it the product topology.

PROPOSITION 3.12. *Given (X, \mathcal{T}_X) and (Y, \mathcal{T}_Y) , $\mathcal{T}_X \times \mathcal{T}_Y$ is indeed a topology on $X \times Y$. Moreover, it is the smallest topology on $X \times Y$ with the property that the two projections*

$$pr_X : X \times Y \rightarrow X, pr_Y : X \times Y \rightarrow Y$$

(sending (x, y) to x , and y , respectively) are continuous.

PROOF. Axiom (T1) is clear. For (T2), let D_1, D_2 be in the product topology, and we show that $D := D_1 \cap D_2$ is as well. To check (5.1), let $(x, y) \in D$. Since D_1 and D_2 satisfy (5.1), for each $i \in \{1, 2\}$, we find $U_i \in \mathcal{T}_X$ and $V_i \in \mathcal{T}_Y$ such that

$$(x, y) \in U_i \times V_i \subset D_i.$$

Then $U := U_1 \cap U_2 \in \mathcal{T}_X$ (axiom (T2) for \mathcal{T}_X), and similarly $V := V_1 \cap V_2 \in \mathcal{T}_Y$, while clearly we have $x \in U, y \in V, U \times V \subset D$. The proof of the axiom (T3) is similar.

For the second part, note that a topology \mathcal{T} on $X \times Y$ has the property that both projections are continuous if and only if $U \times Y \in \mathcal{T}$ and $X \times V \in \mathcal{T}$ for all $U \in \mathcal{T}_X$ and $V \in \mathcal{T}_Y$. Clearly $\mathcal{T}_X \times \mathcal{T}_Y$ has the property, hence the projections are continuous with respect to the product topology. For an arbitrary topology \mathcal{T} on $X \times Y$ with the same property, since

$$U \times V = (U \times Y) \cap (X \times V),$$

we deduce that $U \times V \in \mathcal{T}$ for all $U \in \mathcal{T}_X, V \in \mathcal{T}_Y$. To show that $\mathcal{T}_X \times \mathcal{T}_Y \subset \mathcal{T}$, let D be an open in the product topology and we show that it must belong to \mathcal{T} . Since D satisfies (5.1), for each $z = (x, y) \in D$ we find $U_z \in \mathcal{T}_X, V_z \in \mathcal{T}_Y$ such that

$$\{z\} \subset U_z \times V_z \subset D.$$

Taking the union over all $z \in D$, we deduce that

$$D = \cup_{z \in D} U_z \times V_z.$$

But, as we have already seen, all members $U_z \times V_z$ must be in \mathcal{T} hence, using axiom (T3) for \mathcal{T} , we deduce that $D \in \mathcal{T}$. \square

EXERCISE 3.4. Show that, if (Z, \mathcal{T}_Z) is a third topological space, then a function

$$h = (f, g) : Z \rightarrow X \times Y, h(z) = (f(z), g(z))$$

is continuous if and only if its components $f : Z \rightarrow X$ and $g : Z \rightarrow Y$ are both continuous.

EXAMPLE 3.13. In \mathbb{R}^3 we have the cylinder

$$C = \{(x, y, z) \in \mathbb{R}^3 : x^2 + y^2 = 1, 0 \leq z \leq 1\},$$

which is pictured in Figure 4. According to our conventions, C is considered with the topology induced from \mathbb{R}^3 . On the other hand, since

$$C = S^1 \times [0, 1],$$

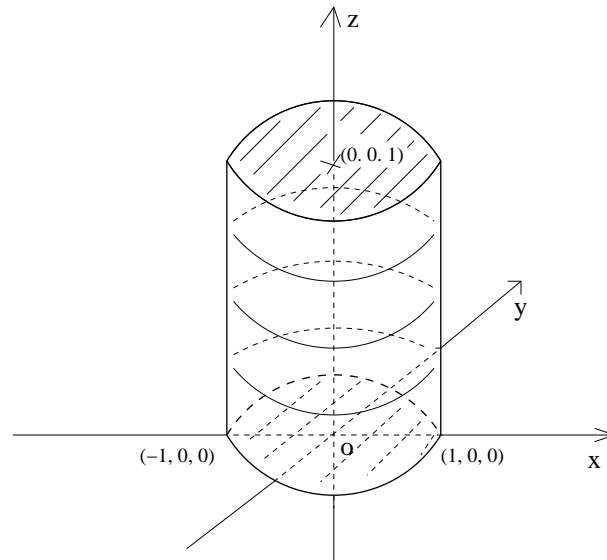

The cylinder in \mathbb{R}^3

FIGURE 4.

where S^1 is the unit circle in \mathbb{R}^2 , C carries yet another natural topology, namely the product topology. These two topologies are the same. This can be proven in a much greater generality, as described in Exercise 3.27.

EXERCISE 3.5. A topological group is a group (G, \cdot) endowed with a topology on G such that all the group operations, i.e.

1. the inversion map $\tau : G \rightarrow G, g \mapsto g^{-1}$,
2. the composition map $m : G \times G \rightarrow G, (g, h) \mapsto g \cdot h$

are continuous (where $G \times G$ is endowed with the product topology).

Note that the sets of matrices $GL_n(\mathbb{R})$, $SL_n(\mathbb{R})$, $O(n)$ that appear in Exercise 2.33, together with multiplication of matrices, are groups. The same exercise describe natural topologies on them (induced from $M_n(\mathbb{R})$). Show that, with respect to these topologies, they are all topological groups.

6. Special classes of quotients II: collapsing a subspace, cones, suspensions

Another class of quotient spaces are quotients obtained by collapsing a subspace to a point.

DEFINITION 3.14. *Let X be a topological space and let $A \subset X$. We define X/A as the topological space obtained from X by collapsing A to a point (i.e. by identifying to each other all the points of A). Equivalently,*

$$X/A = X/R_A,$$

where R_A is the equivalence relation on X defined by

$$R_A = \{(x, y) : x = y \text{ or } x, y \in A\}.$$

Here are some more constructions of this type. Let X be a topological space.

The cylinder on X is defined as

$$\text{Cyl}(X) := X \times [0, 1],$$

endowed with the product topology (and the unit interval is endowed with the Euclidean topology). It contains two interesting copies of X : $X \times \{1\}$ and $X \times \{0\}$.

The cone on X is defined as the quotient obtained from $\text{Cyl}(X)$ by collapsing $X \times \{1\}$ to a point:

$$\text{Cone}(X) := X \times [0, 1]/(X \times \{1\})$$

(endowed with the quotient topology). Intuitively, it looks like a cone with basis X . The cone contains the copy $X \times \{0\}$ of X (the basis of the cone).

The suspension of X is defined as the quotient obtained from $\text{Cone}(X)$ by collapsing the basis $X \times \{0\}$ to a point:

$$S(X) := \text{Cone}(X)/(X \times \{0\}).$$

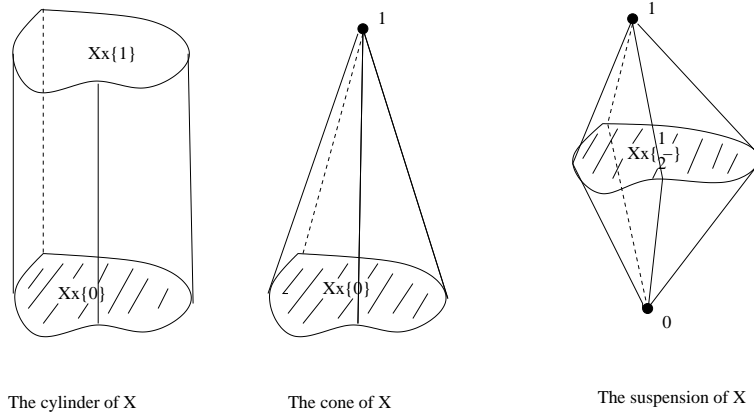

FIGURE 5.

EXAMPLE 3.15. The general constructions of quotients, such as the quotient by collapsing a subspace to a point, the cone construction and the suspension construction, are nicely illustrated by the various relations between the closed unit balls $D^n \subset \mathbb{R}^n$ and the unit spheres $S^n \subset \mathbb{R}^{n+1}$. We mention here the following:

- (i) D^n is homeomorphic to $\text{Cone}(S^{n-1})$ - the cone of S^{n-1} .
- (ii) S^n is homeomorphic to $S(S^{n-1})$ - the suspension of S^{n-1} .
- (iii) S^n is homeomorphic to D^n/S^{n-1} - the space obtained from D^n by collapsing its boundary to a point.

FIGURE 6.

PROOF. The first homeomorphism is indicated in Figure 6 (project the cone down to the disk). It is not difficult to make this precise: we have a map

$$\tilde{f} : S^{n-1} \times [0, 1] \rightarrow D^n, \tilde{f}(x, t) = (1 - t)x.$$

This is clearly continuous and surjective, and it has the property that

$$\tilde{f}(x, t) = \tilde{f}(x', t') \iff (x, t) = (x', t') \text{ or } t = 1,$$

which is precisely the equivalence relation corresponding to the quotient defining the cone. Hence we obtain a continuous bijective map

$$f : \text{Cone}(S^{n-1}) = S^{n-1} \times [0, 1] / (S^{n-1} \times \{1\}) \rightarrow D^n.$$

After we will discuss the notion of compactness, we will be able to conclude that also f^{-1} is continuous, hence f is a homeomorphism. Note that this f sends $S^{n-1} \times \{1\}$ to the boundary of D^n , hence (ii) will follow from (iii). In turn, (iii) is clear on the picture (see Figure 11 in the previous Chapter); the map from D^n to S^n indicated on the picture can be written explicitly as

$$\tilde{g} : D^n \rightarrow S^n, x \mapsto \left(\frac{x_1}{\|x\|} \sin(\pi\|x\|), \dots, \frac{x_n}{\|x\|} \sin(\pi\|x\|), \cos(\pi\|x\|) \right)$$

(well defined for $x \neq 0$) and which sends 0 to the north pole $(0, \dots, 0, 1)$.

One can check directly that

$$\tilde{g}(x) = \tilde{g}(x') \iff x = x' \text{ or } x, x' \in S^{n-1},$$

which is the equivalence relation corresponding to the quotient D^n/S^{n-1} . We deduce that we have a bijective continuous map:

$$g : D^n/S^{n-1} \rightarrow S^n$$

but, again, we leave it to after the discussion of compactness the final conclusion that g is a homeomorphism. \square

7. Constructions of topologies: Bases for topologies

In the construction of metric topologies, the balls were the building pieces. Similarly for the product topology, where the building pieces were the subsets of type $U \times V$ with $U \in \mathcal{T}_X$, $V \in \mathcal{T}_Y$. In both cases, the collection of “building pieces” was not a topology, but “generated” a topology. The abstract notion underlying these constructions is that of topology basis.

DEFINITION 3.16. *Let X be a set and let \mathcal{B} be a collection of subsets of X . We say that \mathcal{B} is a topology basis if it satisfies the following two axioms:*

(B1) *for each $x \in X$ there exists $B \in \mathcal{B}$ such that $x \in B$.*

(B2) *for each $B_1, B_2 \in \mathcal{B}$, and $x \in B_1 \cap B_2$, there exists $B \in \mathcal{B}$ such that $x \in B \subset B_1 \cap B_2$.*

In this case, we define the topology induced by \mathcal{B} as the collection

$$\mathcal{T}(\mathcal{B}) := \{U \subset X : \forall x \in U \exists B \in \mathcal{B} \text{ s.t. } x \in B, B \subset U\}.$$

EXERCISE 3.6. Show that, indeed, for any metric d on X , the collection \mathcal{B}_d of all open balls is a topology basis and topology $\mathcal{T}(\mathcal{B}_d) = \mathcal{T}_d$. Prove a similar statement for the product topology.

We still have to prove that $\mathcal{T}(\mathcal{B})$ is, indeed, a topology (the next proposition). Here we point out a different description of $\mathcal{T}(\mathcal{B})$ (which we have already seen in the case of metric and product topologies- and this is a hint for the next exercise!).

EXERCISE 3.7. Let X be a set and let \mathcal{B} be a collection of subsets of X . Then a subset $U \subset X$ is in $\mathcal{T}(\mathcal{B})$ if and only if there exist $B_i \in \mathcal{B}$ with $i \in I$ (I -an index set) such that $U = \cup_{i \in I} B_i$.

PROPOSITION 3.17. *Given a collection \mathcal{B} of subsets of a set X , the following are equivalent:*

1. \mathcal{B} is a topology basis.
2. $\mathcal{T}(\mathcal{B})$ is a topology on X .

In this case $\mathcal{T}(\mathcal{B})$ is the smallest topology on X which contains \mathcal{B} ; moreover, \mathcal{B} is a basis for the topological space $(X, \mathcal{T}(\mathcal{B}))$, in the sense of Definition 2.47.

PROOF. We prove that the axioms (T1), (T2) and (T3) of a topology (applied to $\mathcal{T}(\mathcal{B})$) are equivalent to axioms (B1) and (B2) of a topology basis (applied to \mathcal{B}). First of all, the previous exercise shows that (T3) is satisfied without any assumption on \mathcal{B} . Next, due to the definition of $\mathcal{T}(\mathcal{B})$, (B1) is equivalent to $X \in \mathcal{T}(\mathcal{B})$. Since clearly $\emptyset \in \mathcal{T}(\mathcal{B})$, (B1) is equivalent to (T1). Hence it suffices to prove that (T2) (for $\mathcal{T}(\mathcal{B})$) is equivalent to (B2) (for \mathcal{B}). That (T2) implies (B2) is immediate: given $B_1, B_2 \in \mathcal{B}$, since they are in $\mathcal{T}(\mathcal{B})$ so is their intersection, i.e. for all $x \in B_1 \cap B_2$ there exists $B \in \mathcal{B}$ such that $x \in B, B \subset B_1 \cap B_2$. For the converse, assume that (B2) holds. To prove (T2) for $\mathcal{T}(\mathcal{B})$, we start with $U, V \in \mathcal{T}(\mathcal{B})$ and we want to prove that $U \cap V \in \mathcal{T}(\mathcal{B})$. I.e., for an arbitrary $x \in U \cap V$, we have to find $B \in \mathcal{B}$ such that $x \in B \subset U \cap V$. Since $x \in U \in \mathcal{T}(\mathcal{B})$, we find $B_1 \in \mathcal{B}$ such that $x \in B_1 \subset U$. Similarly, we find $B_2 \in \mathcal{B}$ such that $x \in B_2 \subset V$. By (B2) we find $B \in \mathcal{B}$ such that $x \in B \subset B_1 \cap B_2$. We deduce that $x \in B \subset U \cap V$, proving (T2). Finally, the last part of the proposition follows from the previous exercise, as any topology which contains \mathcal{B} must contain all unions of sets in \mathcal{B} . \square

Next, since many topologies are defined with the help of a basis, it is useful to know how to compare topologies by only looking at basis elements (see Exercises 3.29 and 3.31).

LEMMA 3.18. *Let \mathcal{B}_1 and \mathcal{B}_2 be two topology bases on X . Then \mathcal{T}_1 is smaller than \mathcal{T}_2 if and only if: for each $B_1 \in \mathcal{B}_1$ and each $x \in B_1$, there exists $B_2 \in \mathcal{B}_2$ such that $x \in B_2 \subset B_1$.*

PROOF. What we have to show is that $\mathcal{T}_1 \subset \mathcal{T}_2$ is equivalent to $\mathcal{B}_1 \subset \mathcal{T}_2$. The direct implication is clear since $\mathcal{B}_1 \subset \mathcal{T}_1$. For the converse, we use the fact that every element in $\mathcal{T}_1 = \mathcal{T}(\mathcal{B}_1)$ can be written as a union of elements of \mathcal{B}_1 ; hence, if $\mathcal{B}_1 \subset \mathcal{T}_2$, every element of \mathcal{T}_1 can be written as a union of elements of \mathcal{T}_2 hence is in itself in \mathcal{T}_2 . \square

8. Constructions of topologies: Generating topologies

8.1. Generated Topologies. There is a slightly more general recipe for generating topologies. What it may happen is that we have a set X , and we are looking for a topology on X which contains certain (specified) subsets of X . In other words,

- we start with a set X and a collection \mathcal{S} of subsets of X

and we are looking for a (interesting) topology \mathcal{T} on X which contains \mathcal{S} . Of course, the discrete topology \mathcal{T}_{dis} on X is always a choice, but it is not a very interesting one (it does not even depend on \mathcal{S}). Is there a “best” one? More precisely:

- is there a smallest possible topology on X which contains \mathcal{S} ?

EXAMPLE 3.19. If $\mathcal{S} = \mathcal{B}$ is a topology basis on the set X , Proposition 3.17 shows that the answer is positive, and the resulting topology is precisely $\mathcal{T}(\mathcal{B})$.

The answer to the question is always “yes”, for any collection \mathcal{S} . Indeed, Exercise 2.20 of the previous chapter tells us that intersections of topologies is a topology. Hence one can just proceed abstractly and define:

$$\langle \mathcal{S} \rangle := \bigcap_{\mathcal{T}\text{-topology on } X \text{ containing } \mathcal{S}} \mathcal{T}$$

This is called the topology generated by \mathcal{S} . By Exercise 2.20, it is a topology. By construction, it is the smallest one containing \mathcal{S} . Of course, this abstract description is not the most satisfactory one. However, using exactly the same type of arguments as in the proof of Proposition 3.17:

PROPOSITION 3.20. *Let X be a set, let \mathcal{S} be a collection of subsets. Define $\mathcal{B}(\mathcal{S})$ as the collection of subsets of X which can be written as finite intersections of subsets that belong to \mathcal{S} . Then $\mathcal{B}(\mathcal{S})$ is a topology basis and the associated topology is precisely $\langle \mathcal{S} \rangle$. In conclusion, a subset $U \subset X$ belongs to $\langle \mathcal{S} \rangle$ if and only if it is a union of finite intersections of members of \mathcal{S} .*

8.2. Initial topologies. Here is a general principle for constructing topologies. Many topological constructions are what we call “natural”, or “canonical” (in any case, not arbitrary). Very often, when one looks for a topology, one wants certain maps to be continuous. This happens e.g. with induced and product topologies. A general setting is as follows.

- start with a set X and a collection of maps $\{f_i : X \rightarrow X_i\}_{i \in I}$ (I is an index set), where each X_i is endowed with a topology \mathcal{T}_i .

We are looking for (interesting) topologies \mathcal{T}_X on X such that all the maps f_i become continuous. As before, this has an obvious but unsatisfactory answer: $\mathcal{T}_X = \mathcal{T}_{\text{dis}}$ (which does not reflect the functions f_i). One should also remark that the smaller \mathcal{T}_X becomes, the smaller are the chances that f_i are continuous. With these, the really interesting question is to

- find the smallest topology on X such that all the functions f_i become continuous.

Now, by the definition of continuity, a topology on X makes the functions f_i continuous if and only if all subsets of type $f_i^{-1}(U_i)$ with $i \in I$, $U_i \in \mathcal{T}_i$, are open. Hence, denoting

$$\mathcal{S} := \{U \subset X : \exists i \in I, \exists U_i \in \mathcal{T}_i \text{ such that } U = f_i^{-1}(U_i)\}$$

the answer to the previous question is: the topology $\langle \mathcal{S} \rangle$ generated by \mathcal{S} . This is called the initial topology on X associated to the starting data (the topological spaces X_i and the functions f_i).

EXAMPLE 3.21. Given a subset A of a topological space (X, \mathcal{T}) , the natural map here is the inclusion $i : A \rightarrow X$. The associated initial topology on A is the induced topology $\mathcal{T}|_A$.

Given two topological spaces (X, \mathcal{T}_X) and (Y, \mathcal{T}_Y) , the Cartesian product $X \times Y$ comes with two natural maps: the projections $\text{pr}_X : X \times Y \rightarrow X$, $\text{pr}_Y : X \times Y \rightarrow Y$. The associated initial topology is the product topology on $X \times Y$.

9. Example: some spaces of functions

Given two sets X and Y we denote by $\mathcal{F}(X, Y)$ the set of all functions from X to Y . In many parts of mathematics, when interested in a certain problem, one deals with subsets of $\mathcal{F}(X, Y)$, endowed with a topology which is relevant to the problem; the topology is dictated by the type of convergence one has to deal with. The list of examples is huge; we will look at some topological examples, i.e. at the set of continuous functions $\mathcal{C}(X, Y) \subset \mathcal{F}(X, Y)$ between two spaces. The general setting will be discussed later. Here we treat the particular case

$X = I \subset \mathbb{R}$ an interval, $Y = \mathbb{R}^n$ endowed with the Euclidean metric d .

Here I could be any interval, open or not, closed or not, equal to \mathbb{R} or not.

There are several notions of convergence on the set $\mathcal{F}(I, \mathbb{R}^n)$ of functions from I to \mathbb{R}^n .

DEFINITION 3.22. Let $\{f_n\}_{n \geq 1}$ be a sequence in $\mathcal{F}(I, \mathbb{R}^n)$, $f \in \mathcal{F}(I, \mathbb{R}^n)$. We say that:

- f_n converges pointwise to f , and we write $f_n \xrightarrow{pt} f$, if $f_n(x) \rightarrow f(x)$ for all $x \in I$.
- f_n converges uniformly to f , and we write $f_n \rightrightarrows f$, if for any $\epsilon > 0$, there exists n_ϵ s.t.

$$d(f_n(x), f(x)) < \epsilon \quad \forall n \geq n_\epsilon, \forall x \in I.$$

- f_n converges uniformly on compacts to f , and we write $f_n \xrightarrow{cp} f$ if, for any compact sub-interval $K \subset I$, $f_n|_K \rightrightarrows f|_K$.

We show that these convergences correspond to certain topologies on $\mathcal{F}(I, \mathbb{R}^n)$. First the pointwise convergence. For $x \in I$, $U \subset \mathbb{R}^n$ open, we define

$$S(x, U) := \{f \in \mathcal{F}(I, \mathbb{R}^n) : f(x) \in U\} \subset \mathcal{F}(I, \mathbb{R}^n).$$

These form a family \mathcal{S} . The topology of pointwise convergence, denoted \mathcal{T}_{pt} , is the topology on $\mathcal{F}(I, \mathbb{R}^n)$ generated by \mathcal{S} . Hence \mathcal{S} defines a topology basis, consisting of finite intersections of members of \mathcal{S} , and \mathcal{T}_{pt} is the associated topology.

PROPOSITION 3.23. *The pointwise convergence coincides with the convergence in $(\mathcal{F}(I, \mathbb{R}^n), \mathcal{T}_{pt})$.*

PROOF. Rewrite the condition that $f_n \rightarrow f$ with respect to \mathcal{T}_{pt} . It means that, for any neighborhood of f of type $S(x, U)$ there exists an integer N such that $f_n \in S(x, U)$ for $n \geq N$. I.e., for any $x \in I$ and any open U containing $f(x)$, there exists an integer N such that $f_n(x) \in U$ for all $n \geq N$. I.e., for any $x \in I$, $f_n(x) \rightarrow f(x)$ in \mathbb{R}^n . \square

For uniform convergence, the situation is more fortunate: it is induced by a metric. Given two functions $f, g \in \mathcal{F}(I, \mathbb{R}^n)$, we define the sup-distance between f and g by

$$d_{\text{sup}}(f, g) = \sup\{d(f(x), g(x)) : x \in I\}.$$

Since this supremum may be infinite for some f and g (and only for that reason!), we define

$$\hat{d}_{\text{sup}}(f, g) = \min(d_{\text{sup}}(f, g), 1).$$

Note that d_{sup} and \hat{d}_{sup} are morally the same when it comes to convergence ($d_{\text{sup}}(f, g)$ is “small” if and only if $\hat{d}_{\text{sup}}(f, g)$ is); they are actually the same on $\mathcal{C}(I, \mathbb{R}^n)$ if I is compact (why?). The associated topology is called the topology of uniform convergence.

EXERCISE 3.8. Show that \hat{d}_{sup} is a metric on $\mathcal{F}(I, \mathbb{R}^n)$.

PROPOSITION 3.24. *The uniform convergence coincides with the convergence in $(\mathcal{F}(I, \mathbb{R}^n), \hat{d}_{\text{sup}})$.*

PROOF. According to the definition of uniform convergence, $f_n \rightrightarrows f$ if and only if for each $\epsilon > 0$, we find n_ϵ such that $d_{\text{sup}}(f_n, f) \leq \epsilon$ for all $n \geq n_\epsilon$. Of course, only ϵ 's small enough matter here, hence we recover the convergence with respect to \hat{d}_{sup} . \square

We now move to uniform convergence on compacts. Given $K \subset I$ a compact subinterval, $\epsilon > 0$, $f \in \mathcal{F}(I, \mathbb{R}^n)$, we define

$$B_K(f, \epsilon) := \{g \in \mathcal{F}(I, \mathbb{R}^n) : d(f(x), g(x)) < \epsilon \ \forall x \in K\}.$$

The topology of compact convergence, denoted \mathcal{T}_{cp} , is the topology on $\mathcal{F}(I, \mathbb{R}^n)$ generated by the family of all the subsets $B_K(f, \epsilon)$. As above, the definitions immediately imply:

PROPOSITION 3.25. *The uniform convergence on compacts coincides with the convergence in the topological space $(\mathcal{F}(I, \mathbb{R}^n), \mathcal{T}_{cp})$.*

In topology, we are interested in continuous functions. The situation is as follows:

THEOREM 3.26. *For a sequence of continuous functions $f_n \in \mathcal{C}(I, \mathbb{R}^n)$, and $f \in \mathcal{F}(I, \mathbb{R}^n)$:*

$$(9.1) \quad (f_n \rightrightarrows f) \implies (f_n \xrightarrow{cp} f) \implies (f \in \mathcal{C}(I, \mathbb{R}^n)).$$

More precisely, one has an inclusion of topologies

$$(\text{pointwise}) \subset (\text{uniform on compacts}) \subset (\text{uniform})$$

and $\mathcal{C}(I, \mathbb{R}^n)$ is closed in $(\mathcal{F}(I, \mathbb{R}^n), \mathcal{T}_{cp})$ (hence also in $(\mathcal{F}(I, \mathbb{R}^n), \hat{d}_{sup})$).

PROOF. The comparison between the three topologies is again a matter of checking the definitions. Also, the first implication in (9.1) is trivial; the second one follows from the last part of the theorem, on which we concentrate next. We first show that $\mathcal{C}(I, \mathbb{R}^n)$ is closed in $(\mathcal{F}(I, \mathbb{R}^n), \hat{d}_{sup})$. Assume that f is in the closure, i.e. $f : I \rightarrow \mathbb{R}^n$ is the uniform limit of a sequence of continuous functions f_n . We show that f is continuous. Let $x_0 \in I$ and we show that f is continuous at x_0 . I.e., we fix $\epsilon > 0$ and we look for a neighborhood V_ϵ of x_0 such that $d(f(x), f(x_0)) < \epsilon$ for all $x \in V_\epsilon$. Since $f_n \rightrightarrows f$, we find N such that $d(f_n(x), f(x)) < \epsilon/3$ for all $n \geq N$ and all $x \in I$. Since f_N is continuous at x_0 , we find a neighborhood V_ϵ such that $d(f_N(x), f_N(x_0)) < \epsilon/3$ for all $x \in V_\epsilon$. But then, for all $x \in V_\epsilon$,

$$d(f(x), f(x_0)) \leq d(f(x), f_N(x)) + d(f_N(x), f_N(x_0)) + d(f_N(x_0), f(x_0)) < 3 \times \epsilon/3 = \epsilon.$$

Finally, we show that $\mathcal{C}(I, \mathbb{R}^n)$ is closed in $(\mathcal{F}(I, \mathbb{R}^n), \mathcal{T}_{cp})$. Assume that f is in the closure. Remark that, for f to be continuous, it suffices that $f|_K$ is continuous for any compact subinterval $K \subset I$. Fix such a K . Considering neighborhoods of type $B_K(f, 1/n)$, we find $f_n \in \mathcal{C}(I, \mathbb{R}^n)$ lying in this neighborhood. But then $f_n|_K \rightrightarrows f|_K$ hence $f|_K$ is continuous. \square

Here is the most important property of the uniform topology (\mathcal{T}_{cp} will be discussed later).

THEOREM 3.27. *$(\mathcal{F}(I, \mathbb{R}^n), \hat{d}_{sup})$ and $(\mathcal{C}(I, \mathbb{R}^n), \hat{d}_{sup})$ are complete metric spaces.*

PROOF. Using the previous theorem and the simple fact that closed subspaces of complete metric spaces are complete, we are left with showing that $(\mathcal{F}(I, \mathbb{R}^n), \hat{d}_{sup})$ is complete. So, let $(f_n)_{n \geq 1}$ be a Cauchy sequence with respect to \hat{d}_{sup} (as mentioned above, for such arguments there is no difference between using d or \hat{d}). Since for all $x \in I$,

$$d(f_n(x), f_m(x)) \leq d_{sup}(f_n, f_m),$$

it follows that $(f_n(x))_{n \geq 1}$ is a Cauchy sequence in (\mathbb{R}^n, d) , for all $x \in X$. Denoting by $f(x)$ the limit, we obtain $f \in \mathcal{F}(I, \mathbb{R}^n)$ (to which f_n converges pointwise). To show that $f_n \rightrightarrows f$, let $\epsilon > 0$ and we look for n_ϵ such that $d_{sup}(f_n, f) < \epsilon$ for all $n \geq n_\epsilon$. For that, use that $(f_n)_{n \geq 1}$ is Cauchy and choose n_ϵ such that $d_{sup}(f_n, f_m) < \epsilon/2$ for all $n, m \geq n_\epsilon$. Combining with the previous displayed inequality, we have $d(f_n(x), f_m(x)) < \epsilon/2$ for all such n, m and all $x \in I$. Taking $m \rightarrow \infty$, we find that $d(f_n(x), f(x)) \leq \epsilon/2 < \epsilon$ for all $n \geq n_\epsilon$ and $x \in I$, i.e. $d_{sup}(f_n, f) < \epsilon$ for all $n \geq n_\epsilon$. \square

10. More exercises

10.1. Quotients.

EXERCISE 3.9. Let T be a model for the torus, with quotient map $\pi : [0, 1] \times [0, 1] \rightarrow T$ (choose your favourite). Give an example of a function $f : [0, 1] \rightarrow [0, 1] \times [0, 1]$ with the property that f is not continuous, but $\pi \circ f$ is.

EXERCISE 3.10. Start with the interval $[0, 2]$ and glue the points 0, 1 and 2. Describe the equivalence relation R encoding this gluing and let $X = [0, 2]/R$. Describe an embedding of X in \mathbb{R}^2 .

EXERCISE 3.11. Show that the space obtained from \mathbb{R} by collapsing $[-1, 1]$ to a point is homeomorphic to \mathbb{R} .

EXERCISE 3.12. Show that the space obtained from \mathbb{R} by collapsing $(-1, 1)$ to a point is not Hausdorff.

EXERCISE 3.13. Let $X = (0, \infty)$. Show that

$$\phi_n(r) := 2^n r$$

defines an action of \mathbb{Z} on X and X/\mathbb{Z} is homeomorphic to S^1 .

(hint: see Example 3.7 and Exercise 1.2).

EXERCISE 3.14. Consider the unit circle in the complex plane

$$S^1 = \{z \in \mathbb{C} : |z| = 1\}.$$

Let n be a positive integer, consider the n -th root of unity

$$\xi = \cos\left(\frac{2\pi}{n}\right) + i\sin\left(\frac{2\pi}{n}\right) \in \mathbb{C}$$

and let \mathbb{Z}_n be the (additive) group of integers modulo n . Show that

$$\phi_k(z) := \xi^k z$$

defines an action of \mathbb{Z}_n on S^1 , explain its geometric meaning, and show that S^1/\mathbb{Z}_n is homeomorphic to S^1 . What do you obtain when $n = 2$?

EXERCISE 3.15. Let R be the equivalence relation on \mathbb{R} consisting of those pairs (r, s) of real numbers with the property that there exist two integers m and n such that $r - s = m + n\sqrt{2}$. Show that the resulting quotient space is not Hausdorff.

EXERCISE 3.16. Let $\Gamma = \mathbb{Z} \times \mathbb{Z}$ with the usual group operation

$$(m, n) + (m', n') = (m + m', n + n').$$

Show that

$$\phi_{m,n}(x, y) := (x + m, y + n)$$

defines an action of Γ on \mathbb{R}^2 and \mathbb{R}^2/Γ is homeomorphic to the torus.

EXERCISE 3.17. Do the same for the same group but the new action:

$$\phi_{m,n}(x, y) := \left(x + my + n + \frac{m(m-1)}{2}, y + m\right).$$

EXERCISE 3.18. Consider the following groups:

1. $\Gamma = \langle a, b; bab = a \rangle$ (the group in two generators a and b , subject to the relation $bab = a$).
2. $\Gamma' = \mathbb{Z} \times \mathbb{Z}$ with the operation

$$(m, n) \circ (m', n') = (m + m', n + (-1)^m n').$$

3. Γ' is the subgroup of $(\text{Homeo}(\mathbb{R}^2), \circ)$ (the group of homeomorphisms of the plane endowed with the composition of functions) generated by the transformations

$$\phi(x, y) = (x + 1, -y), \psi(x, y) = (x, y + 1).$$

Show that:

1. these three groups are isomorphic.
2. one obtains an action of these groups on \mathbb{R}^2 ; write it down explicitly.
3. the resulting quotient is homeomorphic to the Klein bottle.

EXERCISE 3.19. Compose and solve a similar exercise in which the resulting quotient is homeomorphic to the Moebius band.

EXERCISE 3.20.

- (i) Write the Moebius band as a union of two subspaces M and C where M is itself a Moebius band, C is a cylinder (i.e. homeomorphic to $S^1 \times [0, 1]$) and $M \cap C$ is a circle.
- (ii) Similarly, decompose \mathbb{P}^2 as the union of a Moebius band M and another subspace Q , such that Q is a quotient of the cylinder and $M \cap Q$ is a circle.
- (iii) Deduce that \mathbb{P}^2 can be obtained from a Moebius band and a disk D^2 by gluing them along their boundary circles.

EXERCISE 3.21. Show that

1. \mathbb{P}^n is an n -dimensional topological manifold.
2. The map $f : \mathbb{P}^n \rightarrow \mathbb{R}^{\frac{(n+1)(n+2)}{2}}$ which sends the line l_x through $x = (x_0, \dots, x_n)$ to

$$f(l_x) = (x_0x_0, x_0x_1, \dots, x_0x_n, x_1x_1, x_1x_2, \dots, x_1x_n, \dots, x_nx_n)$$

is an embedding.

10.2. Product topology.

EXERCISE 3.22. Show that

$$(\mathbb{R}^n, \mathcal{T}_{\text{eucl}}) \times (\mathbb{R}^m, \mathcal{T}_{\text{eucl}}) = (\mathbb{R}^{n+m}, \mathcal{T}_{\text{eucl}}).$$

EXERCISE 3.23. Show that if X and Y are both Hausdorff, then so is $X \times Y$. Similarly for metrizable and first countability.

EXERCISE 3.24. Look at exercise 2.22 and show that there is no conflict in the notation; i.e. the topology $\mathcal{T}_l \times \mathcal{T}_l$ defined in that exercise does coincide with the product topology.

EXERCISE 3.25. Show that if n is an odd number, then $GL_n(\mathbb{R})$ is homeomorphic to $GL_1(\mathbb{R}) \times SL_n(\mathbb{R})$ (see Exercise 2.33).

EXERCISE 3.26. Show that a topological space X is Hausdorff if and only if

$$\Delta := \{(x, x) : x \in X\}$$

is closed in $X \times X$.

EXERCISE 3.27. Let X and Y be two topological spaces, $A \subset X$, $B \subset Y$. Then the following two topologies on $A \times B$ coincide:

- (i) The product of the topology of A (induced from X) and that of B (induced from Y).
- (ii) The topology induced on $A \times B$ from the product topology on $X \times Y$.

EXERCISE 3.28. Let X be the cone of the interval $(0, 1)$. Construct an explicit continuous injection

$$f : X \rightarrow \mathbb{R}^2$$

and let C be its image. Is f a homeomorphism?

10.3. Topology bases.

EXERCISE 3.29. Using Lemma 3.18, prove again that the Euclidean and the square metrics induce the same topology.

EXERCISE 3.30. Go back to exercise 2.17 and show that \mathcal{B} there is a topology basis. Then using Lemma 3.18, show again that the resulting topology is larger than the topology from Exercise 2.16.

EXERCISE 3.31. Show that

$$\mathcal{B}_I := \{[a, b) : a, b \in \mathbb{R}\}$$

is a topology basis and $\mathcal{T}(\mathcal{B}_I)$ is the topology \mathcal{T}_I from Exercise 2.19. Then use Lemma 3.18 to prove again that \mathcal{T}_I is finer than $\mathcal{T}_{\text{Eucl}}$.

EXERCISE 3.32. Do again Exercise 2.22 using Lemma 3.18.

EXERCISE 3.33. Consider the unit circle S^1 and the functions

$$\alpha, \beta : S^1 \rightarrow \mathbb{R}, \alpha(x, y) = x, \beta(x, y) = y.$$

Show that:

1. S^1 , endowed with the smallest topology which makes α continuous, is not Hausdorff.
2. the smallest topology on S^1 which makes both α and β continuous is the Euclidean one.

10.4. Spaces of functions.

EXERCISE 3.34. Let $f_n : \mathbb{R} \rightarrow \mathbb{R}$, $f_n(x) = \frac{1}{n} \sin(nx)$. Show that (f_n) is uniformly convergent.

EXERCISE 3.35. Let $f_n : \mathbb{R} \rightarrow \mathbb{R}$, $f_n(x) = x^n$. Is (f_n) pointwise convergent? But uniformly on compacts? But uniformly?

EXERCISE 3.36. Let $f_n : \mathbb{R} \rightarrow \mathbb{R}$, $f_n(x) = \frac{x}{n}$. Is (f_n) pointwise convergent? But uniformly on compacts? But uniformly?

EXERCISE 3.37. (*Dini's theorem*) Let $f_n : I \rightarrow \mathbb{R}$ be an increasing sequence of continuous functions defined on an interval I , which converges pointwise to a continuous function f . Show that $f_n \rightrightarrows f$. Is the same true if we do not assume that f is continuous?

EXERCISE 3.38. Let $p_n \in \mathcal{C}([0, 1], \mathbb{R})$ be the sequence of functions (even polynomials!) defined inductively by

$$p_{n+1}(t) = p_n(t) + \frac{1}{2}(t - p_n(t))^2, \quad p_1 = 0.$$

Show that (p_n) converges uniformly to the function $f(t) = \sqrt{t}$.

(Hint: first show that $p_n(t) \leq \sqrt{t}$, then that $p_n(t)$ is increasing, then that it converges pointwise to \sqrt{t} , then look above).

EXERCISE 3.39. Now, did you know that there are continuous surjective functions $f : [0, 1] \rightarrow [0, 1] \times [0, 1]$??? (yes, continuous curves in the plane which fill up an entire square!). Actually, you now have all the knowledge to show that (using Theorem 3.27); it is not obvious but, once you see the pictures, the proof is not too difficult; have a look at Munkres' book.

CHAPTER 4

Topological properties

1. Connectedness

- Definitions and examples
- Basic properties
- Connected components
- Connected versus path connected, again

2. Compactness

- Definition and first examples
- Topological properties of compact spaces
- Compactness of products, and compactness in \mathbb{R}^n
- Compactness and continuous functions
- Embeddings of compact manifolds
- Sequential compactness
- More about the metric case

3. Local compactness and the one-point compactification

- Local compactness
- The one-point compactification

4. More exercises

1. Connectedness

1.1. Definitions and examples.

DEFINITION 4.1. We say that a topological space (X, \mathcal{T}) is connected if X cannot be written as the union of two disjoint non-empty opens $U, V \subset X$.

We say that a topological space (X, \mathcal{T}) is path connected if for any $x, y \in X$, there exists a path γ connecting x and y , i.e. a continuous map $\gamma: [0, 1] \rightarrow X$ such that $\gamma(0) = x$, $\gamma(1) = y$.

Given (X, \mathcal{T}) , we say that a subset $A \subset X$ is connected (or path connected) if A , together with the induced topology, is connected (path connected).

As we shall soon see, path connectedness implies connectedness. This is good news since, unlike connectedness, path connectedness can be checked more directly (see the examples below).

EXAMPLE 4.2.

- (1) $X = \{0, 1\}$ with the discrete topology is not connected. Indeed, $U = \{0\}$, $V = \{1\}$ are disjoint non-empty opens (in X) whose union is X .
- (2) Similarly, $X = [0, 1) \cup [2, 3]$ is not connected (take $U = [0, 1)$, $V = [2, 3]$). More generally, if $X \subset \mathbb{R}$ is connected, then X must be an interval. Indeed, if not, we find $r, s \in X$ and $t \in (r, s)$ such that $t \notin X$. But then $U = (-\infty, t) \cap X$, $V = (t, \infty) \cap X$ are opens in X , nonempty (as $r \in U$, $s \in V$), disjoint, with $U \cup V = X$ (as $t \notin X$).
- (3) However, although true, the fact that any interval $I \subset \mathbb{R}$ is connected is not entirely obvious. In contrast, the path connectedness of intervals is clear: for any $x, y \in I$,

$$\gamma: [0, 1] \rightarrow \mathbb{R}, \gamma(t) = (1-t)x + ty$$

takes values in I (since I is an interval) and connects x and y .

- (4) Similarly, any convex subset $X \subset \mathbb{R}^n$ is path connected (recall that X being convex means that for any $x, y \in X$, the whole segment $[x, y]$ is contained in X).
- (5) $X = \mathbb{R}^2 - \{0\}$, although not convex, is path connected: if $x, y \in X$ and the segment $[x, y]$ does not contain the origin, we use the linear path from x to y . But even if $[x, y]$ contains the origin, we can join them by a path going around the origin (see Figure 1).

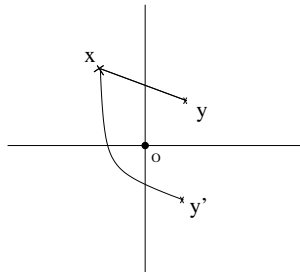

$\mathbb{R}^2 - \{0\}$ is path connected

FIGURE 1.

LEMMA 4.3. *The unit interval $[0, 1]$ is connected.*

PROOF. We assume the contrary: \exists disjoint non-empty U, V , opens in $[0, 1]$ such that $U \cup V = [0, 1]$. Since $U = [0, 1] - V$, U must be closed in $[0, 1]$. Hence, as a limit of points in U , $R := \sup U$ must belong to U . We claim that $R = 1$. If not, we find an interval $(R - \epsilon, R + \epsilon) \subset U$ and then $R + \frac{1}{2}\epsilon$ is an element in U strictly greater than its supremum- which is impossible. In conclusion, $1 \in U$. But exactly the same argument shows that $1 \in V$, and this contradicts the fact that $U \cap V = \emptyset$. \square

1.2. Basic properties.

PROPOSITION 4.4.

- (i) If $f : X \rightarrow Y$ is a continuous map and X is connected, then $f(X)$ is connected.
- (ii) Given (X, \mathcal{T}) , if for any two points $x, y \in X$, there exists $\Gamma \subset X$ connected such that $x, y \in \Gamma$, then X is connected.

PROOF. For (i), replacing Y by $f(X)$, we may assume that f is surjective, and we want to prove that Y is connected. If it is not, we find $U, V \subset Y$ disjoint nonempty opens whose union is Y . But then $f^{-1}(U), f^{-1}(V) \subset X$ are disjoint (since U and V are), nonempty (since U and V are and f is surjective) opens (because f is continuous) whose union is X - and this contradicts the connectedness of X . For (ii) we reason again by contradiction, and we assume that X is not connected, i.e. $X = U \cup V$ for some disjoint nonempty opens U and V . Since they are non-empty, we find $x \in U, y \in V$. By hypothesis, we find Γ connected such that $x, y \in \Gamma$. But then

$$U' = U \cap \Gamma, V' = V \cap \Gamma$$

are disjoint non-empty opens in Γ whose union is Γ - and this contradicts the connectedness of Γ . \square

THEOREM 4.5. *Any path connected space X is connected.*

PROOF. We use (ii) of the proposition. Let $x, y \in X$. We know there exists $\gamma : [0, 1] \rightarrow X$ joining x and y . But then $\Gamma = \gamma([0, 1])$ is connected by using (i) of the proposition and the fact that $[0, 1]$ is connected; also, $x, y \in \Gamma$. \square

Since we have already remarked that a connected subset of \mathbb{R} must be an interval, and that any interval is path connected, the theorem implies:

COROLLARY 4.6. *The only connected subsets of \mathbb{R} are the intervals.*

Combining with part (i) of Proposition 4.4 we deduce the following:

COROLLARY 4.7. *If X is connected and $f : X \rightarrow \mathbb{R}$ is continuous, then $f(X)$ is an interval.*

COROLLARY 4.8. *If X is connected, then any quotient of X is connected.*

EXAMPLE 4.9. There are a few more consequences that one can derive by combining connectedness properties with the “removing one point trick” (Exercise 2.39 in Chapter 2).

- (1) \mathbb{R} cannot be homeomorphic to S^1 . Indeed, if we remove a point from \mathbb{R} the result is disconnected, while if we remove a point from S^1 , the result stays connected.
- (2) \mathbb{R} cannot be homeomorphic to \mathbb{R}^2 . The argument is similar to the previous one (recall that $\mathbb{R}^2 - \{0\}$ is path connected, hence connected).
- (3) The more general statement that \mathbb{R}^n and \mathbb{R}^m cannot be homeomorphic if $n \neq m$ is much more difficult to prove. One possible proof is a generalization of the argument given above (when $n = 1, m = 2$)- but that is based on “higher versions of connectedness”, a notion which is at the core of algebraic topology.

EXERCISE 4.1. Show that $[0, 1)$ and $(0, 1)$ are not homeomorphic.

1.3. Connected components.

DEFINITION 4.10. Let (X, \mathcal{T}) be a topological space. A connected component of X is any maximal connected subset of X , i.e. any connected $C \subset X$ with the property that, if $C' \subset X$ is connected and contains C , then C' must coincide with C .

PROPOSITION 4.11. Let (X, \mathcal{T}) be a topological space. Then

- (i) Any point $x \in X$ belongs to a connected component of X .
- (ii) If C_1 and C_2 are connected components of X then either $C_1 = C_2$ or $C_1 \cap C_2 = \emptyset$.
- (iii) Any connected component of X is closed in X .

PROOF. To prove the proposition we will use the following

EXERCISE 4.2. If $A, B \subset X$ are connected and $A \cap B \neq \emptyset$, then $A \cup B$ is connected.

For (i) of the proposition, let $x \in X$ and define $C(x)$ as the union of all connected subsets of X containing x . We claim that $C(x)$ is a connected component. The only thing that is not clear is the connectedness of $C(x)$. To prove that, we will use the criterion given by (ii) of Proposition 4.4. For $y, z \in C(x)$ we have to find $\Gamma \subset X$ connected such that $y, z \in \Gamma$. Due to the definition of $C(x)$, we find C_y and C_z - connected subsets of X , both containing x , such that $y \in C_y, z \in C_z$. The previous exercise implies that $\Gamma := C_y \cup C_z$ is connected containing both y and z .

To prove (ii), we use again the previous exercise applied to $A = C_1$ and $B = C_2$, and the maximality property of connected components.

To prove (iii), due to the maximality of connected components, it suffices to prove that if $C \subset X$ is connected, then \overline{C} is connected. Assume that $Y := \overline{C}$ is not connected. We find D_1, D_2 nonempty opens in Y , disjoint, such that $Y = D_1 \cup D_2$. Take $U_i = C \cap D_i$. Clearly, U_1 and U_2 are disjoint opens in C , with $C = U_1 \cup U_2$. To reach a contradiction (with the fact that C is connected) it suffices to show that U_1 and U_2 are nonempty. To show that U_i is non-empty ($i \in \{1, 2\}$), we use the fact that D_i is non-empty. We find a point $x_i \in D_i$. Since x_i is in the closure of C in Y , we have $U \cap C \neq \emptyset$ for each neighborhood U of x_i in Y . Choosing $U = D_i$, we have $C \cap D_i \neq \emptyset$. \square

REMARK 4.12. From the previous proposition we deduce that, for any topological space (X, \mathcal{T}) , the family $\{C_i\}_{i \in I}$ of connected components of (X, \mathcal{T}) (where I is an index set) give a partition of X :

$$X = \cup_{i \in I} C_i, \quad C_i \cap C_j = \emptyset \quad \forall i \neq j,$$

called the partition of X into connected components.

EXERCISE 4.3. Let X be a topological space and assume that $\{X_1, \dots, X_n\}$ is a finite partition of X , i.e.

$$X = X_1 \cup \dots \cup X_n, \quad X_i \cap X_j = \emptyset \quad \forall i \neq j.$$

Then the following are equivalent:

- (i) All X_i 's are closed.
- (ii) All X_i 's are open.

If moreover each X_i is connected, then $\{X_1, \dots, X_n\}$ coincides with the partition of X into connected components.

1.4. Connected versus path connected, again. Theorem 4.5 shows that path connectedness implies connectedness. However, the converse does not hold in general. The standard example is “the flea and comb”, drawn in Figure 2. Explicitly, $X = C \cup \{f\}$, where

$$C = [0, 1] \cup \left\{ \left(\frac{1}{n}, y \right) : y \in [0, 1], n \in \mathbb{Z}_{>0} \right\}, \quad f = (0, 1).$$



The flea and comb

FIGURE 2.

EXERCISE 4.4. Show that, indeed, X from the picture is connected but not path connected. However, there is a partial converse to Theorem 4.5.

THEOREM 4.13. *Let (X, \mathcal{T}) be a topological space with the property that any point of X has a path connected neighborhood. Then X is path connected if and only if it is connected.*

PROOF. We still have to prove that, if X is connected, then it is also path connected. We define on X the following relation \sim : $x \sim y$ if and only if x and y can be joined by a (continuous) path. This is an equivalence relation. Indeed, for $x, y, z \in X$:

- $x \sim x$: consider the constant path.
- if $x \sim y$ then $y \sim x$: if γ is a path from x to y , then $\gamma^{-1}(t) = \gamma(1 - t)$ is a path from y to x .
- if $x \sim y$ and $y \sim z$, then $x \sim z$. Indeed, if γ_1 is a path from x to y , while γ_2 from y to z , then

$$\gamma(t) = \begin{cases} \gamma_1(2t) & \text{if } t \in [0, \frac{1}{2}] \\ \gamma_2(2t - 1) & \text{if } t \in [\frac{1}{2}, 1] \end{cases}$$

is a path from x to z .

For $x \in X$, we denote by $C(x)$ the equivalence class of x :

$$C(x) = \{y \in X : y \sim x\}.$$

Note that each $C(x)$ is path connected. We claim that $C(x) = X$ for any $x \in X$. The fact that \sim is an equivalence relation implies that

$$\{C(x) : x \in X\}$$

is a partition of X : if $C(x) \cap C(x') \neq \emptyset$, then $C(x) = C(x')$. What we want to prove is that this partition consists of one set only. Since X is connected, it is enough to prove that $C(x)$ is open for each $x \in X$. Fixing x , we want to prove that for any $y \in C(x)$, there is an open U such that $y \in U \subset C(x)$. To see this, we use the hypothesis and we choose any path connected neighborhood V of y . Since $y \sim x$ and $z \sim y$ for any $z \in V$, we deduce that $z \sim x$ for any $z \in V$, hence $V \subset C(x)$. Since V is a neighborhood of y , we find U open such that $y \in U \subset V$, and this U clearly has the desired properties. \square

EXERCISE 4.5. Find a subspace $X \subset \mathbb{R}^2$ which is connected but not path connected.

2. Compactness

2.1. Definition and first examples. Probably many of you have seen the notion of compact space in the context of subsets of \mathbb{R}^n , as sets which are closed and bounded. Although not obviously at all, this is a topological property (it can be defined using open sets only).

DEFINITION 4.14. *Given a topological space (X, \mathcal{T}) an open cover of X is a family $\mathcal{U} = \{U_i : i \in I\}$ (I -some index set) consisting of open sets $U_i \subset X$ such that*

$$X = \cup_{i \in I} U_i.$$

A subcover is any cover \mathcal{V} with the property that $\mathcal{V} \subset \mathcal{U}$.

We say that a topological space (X, \mathcal{T}) is compact if from any open cover $\mathcal{U} = \{U_i : i \in I\}$ of X one can extract a finite open subcover, i.e. there exist $i_1, \dots, i_k \in I$ such that

$$X = U_{i_1} \cup \dots \cup U_{i_k}.$$

REMARK 4.15. Given a topological space (X, \mathcal{T}) and $A \subset X$, the compactness of A (viewed as a topological space with the topology induced from X (cf. Example 2.8 in Chapter 2) can be expressed using “open coverings of A in X ”, i.e. families $\mathcal{U} = \{U_i : i \in I\}$ (I -some index set) consisting of open sets $U_i \subset X$ such that

$$A \subset \cup_{i \in I} U_i.$$

A subcover is any cover (of A in X) \mathcal{V} with the property that $\mathcal{V} \subset \mathcal{U}$. With these, A is compact if and only if from any open cover of A in X one can extract a finite open subcover. This follows immediately from the fact that the opens for the induced topology on A are of type $A \cap U$ with $U \in \mathcal{T}$ and from the fact that, for a family $\{U_i : i \in I\}$, we have

$$\bigcup_i (A \cap U_i) = A \iff A \subset \bigcup_i U_i,$$

EXAMPLE 4.16.

- (1) $(X, \mathcal{T}_{\text{discr}})$ is compact if and only if X is finite (use the cover of X by the open-point opens).
- (2) \mathbb{R} is not compact. Indeed,

$$\mathbb{R} = \bigcup_{k \in \mathbb{Z}} (-k, k)$$

is an open cover from which we cannot extract a finite open subcover. By the same argument, any compact $A \subset \mathbb{R}^n$ must be bounded (e.g., when $n = 1$, write $A \subset \cup_k (-k, k)$).

- (3) $[0, 1)$ is not compact. Indeed,

$$[0, 1) \subset \bigcup_k (-\infty, 1 - \frac{1}{k})$$

defines an open cover of $[0, 1)$ in \mathbb{R} , from which we cannot extract a finite open subcover. By a similar argument, any compact $A \subset \mathbb{R}^n$ must be closed in \mathbb{R}^n . To show this, assume for simplicity that $n = 1$. We proceed by contradiction and assume that there exists $a \in \overline{A} - A$. Since $a \notin A$,

$$U_\epsilon := \mathbb{R} - [a - \epsilon, a + \epsilon]$$

form an open cover of A in \mathbb{R} indexed by $\epsilon > 0$. Extracting a finite subcover, we find

$$A \subset U_{\epsilon_1} \cap \dots \cap U_{\epsilon_k} = U_\epsilon \text{ where } \epsilon = \min\{\epsilon_1, \dots, \epsilon_k\}.$$

But this implies that $A \cap (a - \epsilon, a + \epsilon) = \emptyset$ which contradicts $a \in \overline{A}$.

- (4) $[0, 1]$ is compact.

PROOF. Assume the contrary, i.e. there exists a “bad cover of $[0, 1]$ ”, i.e. an open cover \mathcal{U} of $[0, 1]$ in \mathbb{R} which does not admit any finite open subcover (of $[0, 1]$ in \mathbb{R}). Divide $[0, 1]$ into two intervals of equal length. Then \mathcal{U} will be a bad cover for at least one of the two intervals, call it I_1 . Divide now I_1 into two intervals of equal length and, again, choose one of them, call it I_2 , so that \mathcal{U} is a bad cover of I_2 . Continuing this process, we find intervals I_k with

$$I_{k+1} \subset I_k, \text{diam}(I_k) = \frac{1}{2^k},$$

(where the diameter of an interval $[a, b]$ is $(b - a)$) and such that \mathcal{U} is a bad open cover of I_k in \mathbb{R} . Choosing $x_k \in I_k$, we have

$$d(x_k, x_{k+1}) \leq \frac{1}{2^k}$$

for all k , where d denotes the Euclidean metric ($d(a, b) = |a - b|$). We claim that the sequence of real numbers $(x_k)_{k \geq 1}$ is a Cauchy sequence, i.e. $d(x_k, x_{k+n})$ can be made arbitrarily small for k big enough and all n . To see this, we use the triangle inequality and the previous inequality repeatedly:

$$d(x_k, x_{k+n}) \leq \sum_{i=k}^{k+n-1} d(x_i, x_{i+1}) \leq \sum_{i=k}^{k+n-1} \frac{1}{2^i} = \frac{1}{2^{k-1}} \left(1 - \frac{1}{2^n}\right),$$

and deduce

$$d(x_k, x_{k+n}) < \frac{1}{2^{k-1}}$$

for all $k, n \geq 0$ integers. This shows that $(x_k)_{k \geq 1}$ is a Cauchy sequence, so, from the known properties of the real line, the sequence will be convergent. Let x be its limit. Since $x_k \in [0, 1]$ for all k , we deduce that $x \in [0, 1]$. Taking $n \rightarrow \infty$ in the previous inequality we also deduce that

$$d(x_k, x) \leq \frac{1}{2^{k-1}}.$$

We deduce that, for each k ,

$$I_k \subset \left[x - \frac{3}{2^k}, x + \frac{3}{2^k}\right].$$

Indeed, if $y \in I_k$, since $x_k \in I_k$ and the diameter of I_k is $1/2^k$, we have $d(y, x_k) \leq 1/2^k$, hence

$$d(y, x) \leq d(y, x_k) + d(x_k, x) \leq \frac{1}{2^k} + \frac{1}{2^{k-1}} = \frac{3}{2^k}.$$

We now use the cover \mathcal{U} . Let $U \in \mathcal{U}$ such that $x \in U$. Since U is open, we find $r > 0$ such that

$$(x - r, x + r) \subset U.$$

But then, choosing k such that $\frac{3}{2^k} < r$, we will have $I_k \subset (x - r, x + r) \subset U$, i.e. the open cover \mathcal{U} of I_k in \mathbb{R} will have a finite subcover—namely the one consisting of the open set U alone. This contradicts the fact that \mathcal{U} was a bad cover for I_k . \square

EXERCISE 4.6. Show that the set

$$\left\{0, 1, \frac{1}{2}, \frac{1}{3}, \frac{1}{4}, \dots\right\}$$

is compact in \mathbb{R} .

2.2. Topological properties of compact spaces. In this section we point out some topological properties of compact spaces.

The first one says that “closed inside compact is compact”.

PROPOSITION 4.17. *If (X, \mathcal{T}) is a compact space, then any closed subset $A \subset X$ is compact.*

The second one says that “compact inside Hausdorff is closed”.

THEOREM 4.18. *In a Hausdorff space (X, \mathcal{T}) , any compact set is closed.*

The third one says that “disjoint compacts inside a Hausdorff can be separated”.

PROPOSITION 4.19. *In a Hausdorff space (X, \mathcal{T}) , any two disjoint compact sets A and B can be separated topologically, i.e. there exist opens $U, V \subset X$ such that*

$$A \subset U, B \subset V, U \cap V = \emptyset.$$

COROLLARY 4.20. *Any compact Hausdorff space is normal.*

PROOF. (of Proposition 4.17) If \mathcal{U} is an open cover of A in X , then adding $X - A$ to \mathcal{U} (which is open since A is closed), we get an open cover of X . Extracting a finite subcover (which may or may not contain $X - A$), denoting by U_1, \dots, U_n the elements of this finite subcover which are different from $X - A$, this will define a finite subcover of the original cover of A in X . \square

PROOF. (of Proposition 4.19): We introduce the following notation: given $Y, Z \subset X$ we write $Y|Z$ if Y and Z can be separated, i.e. if there exist opens U and V (in X) such that $Y \subset U$, $Z \subset V$ and $U \cap V = \emptyset$. We claim that, if Z is compact and $Y|\{z\}$ for all $z \in Z$, then $Y|Z$.

PROOF. (of the claim) We know that for each $z \in Z$ we find opens U_z and V_z such that $Y \subset U_z$, $z \in V_z$ and $U_z \cap V_z = \emptyset$. Note that $\{V_z : z \in Z\}$ is an open cover of Z in X : indeed, any $z \in Z$ belongs at least to one of the opens in the cover (namely V_z). By compactness of Z , we find a finite number of points $z_1, \dots, z_n \in Z$ such that

$$Z \subset V_{z_1} \cup \dots \cup V_{z_n}.$$

Denoting by V the last union, and considering

$$U = U_{z_1} \cap \dots \cap U_{z_n},$$

V is an open containing Z , U is an open containing Y . Moreover, $U \cap V = \emptyset$: indeed, if x is in the intersection, since $x \in V$ we find k such that $x \in V_{z_k}$; but $x \in U$ hence $x \in U_{z_k}$, which is impossible since $U_{z_k} \cap V_{z_k} = \emptyset$. In conclusion, U and V show that Y and Z can be separated. \square

Back to the proof of the proposition, let $a \in A$ arbitrary. Now, since X is Hausdorff, we have $\{a\}|\{b\}$ for all $b \in B$. Since B is compact, the claim above implies that $\{a\}|B$, or, equivalently, $B|\{a\}$. This holds for all $a \in A$, hence using again the claim (and the fact that A is compact) we deduce that $A|B$. \square

PROOF. (of Theorem 4.18) For Theorem 4.18, assume that $A \subset X$ is compact, and we prove that $\overline{A} \subset A$: if $x \in \overline{A}$, then, for any neighborhood U of x , $U \cap A \neq \emptyset$, and this shows that x cannot be separated from A ; using the proposition, we conclude that $x \in A$. \square

EXERCISE 4.7. Deduce that a subset $A \subset \mathbb{R}$ is compact if and only if it is closed and bounded. What is missing to prove the same for subsets of \mathbb{R}^n ?

2.3. Compactness of products, and compactness in \mathbb{R}^n . Next, we are interested in the compactness of the product of two compact spaces. We will use the following:

LEMMA 4.21. (*the Tube Lemma*) Let X and Y be two topological spaces, $x_0 \in X$, and let $U \subset X \times Y$ be an open (in the product topology) such that

$$\{x_0\} \times Y \subset U.$$

If Y is compact, then there exists $W \subset X$ open containing x_0 such that

$$W \times Y \subset U.$$

PROOF. Due to the definition of the product topology, for each $y \in Y$, since $(x_0, y) \in U$, there exist opens $W_y \subset X$, $V_y \subset Y$ such that

$$W_y \times V_y \subset U.$$

Now, $\{V_y : y \in Y\}$ will be an open cover of Y , hence we find $y_1, \dots, y_n \in Y$ such that

$$Y = V_{y_1} \cup \dots \cup V_{y_n}.$$

Choose $W = W_{y_1} \cap \dots \cap W_{y_n}$, which is an open containing x_0 , as a finite intersection of such. To check $W \times Y \subset U$, let $(x, y) \in W \times Y$. Since the V_{y_i} 's cover Y , we find i s.t. $y \in V_{y_i}$. But $x \in W$ implies $x \in W_{y_i}$, hence $(x, y) \in W_{y_i} \times V_{y_i}$. But $W_z \times V_z \subset U$ for all $z \in Y$, hence $(x, y) \in U$. \square

THEOREM 4.22. *If X and Y are compact spaces, then $X \times Y$ is compact.*

PROOF. Let \mathcal{U} be an open cover of $X \times Y$. For each $x \in X$,

$$\{x\} \times Y \subset X \times Y$$

is compact (why?), hence we find a $\mathcal{U}_x \subset \mathcal{U}$ finite such that

$$(2.1) \quad \{x\} \times Y \subset \bigcup_{U \in \mathcal{U}_x} U.$$

Using the previous lemma, we find W_x open containing x such that

$$(2.2) \quad W_x \times Y \subset \bigcup_{U \in \mathcal{U}_x} U.$$

Now, $\{W_x : x \in X\}$ is an open cover of X , hence we find a finite subcover

$$X = W_{x_1} \cup \dots \cup W_{x_p}.$$

Then

$$\mathcal{V} = \mathcal{U}_{x_1} \cup \dots \cup \mathcal{U}_{x_p}$$

is finite union of finite collections, hence finite. Moreover, \mathcal{V} still covers $X \times Y$: given (x, y) arbitrary, using (2.2), we find i such that $x \in W_{x_i}$. Hence $(x, y) \in W_{x_i} \times Y$, and using (2.1) we find $U \in \mathcal{U}_{x_i}$ such that $(x, y) \in U$. Hence we found $U \in \mathcal{V}$ such that $(x, y) \in U$, \square

COROLLARY 4.23. *A subset $A \subset \mathbb{R}^n$ is compact if and only if it is closed and bounded.*

PROOF. The direct implication was already mentioned in Example 4.16 (and that A is closed follows also from Theorem 4.18). For the converse, since A is bounded, we find $R, r \in \mathbb{R}$ such that $A \subset [r, R]^n$. The intervals $[r, R]$ are homeomorphic to $[0, 1]$, hence compact. The previous theorem implies that $[r, R]^n$, hence A must be compact as closed inside a compact. \square

EXAMPLE 4.24. In particular, spaces like the spheres S^n , the closed disks D^n , the Moebius band, the torus, etc, are compact.

2.4. Compactness and continuous functions.

THEOREM 4.25. *If $f : X \rightarrow Y$ is a continuous function and $A \subset X$ is compact, then $f(A) \subset Y$ is compact.*

PROOF. If \mathcal{U} is an open cover of $f(A)$ in Y , then $f^{-1}(\mathcal{U}) := \{f^{-1}(U) : U \in \mathcal{U}\}$ is an open cover of A in X , hence it has a finite subcover $\{f^{-1}(U_i) : 1 \leq i \leq n\}$ with $U_i \in \mathcal{U}$. But then $\{U_i\}$ will be a finite subcover of \mathcal{U} . \square

Finally, we can state the property of compact spaces that we referred to several times when having to prove that certain continuous injections are homeomorphisms.

THEOREM 4.26. *If $f : X \rightarrow Y$ is continuous and bijective, and if X is compact and Y is Hausdorff, then f is a homeomorphism.*

PROOF. We have to show that the inverse g of f is continuous. For this we show that if U is open in X then the pre-image $g^{-1}(U)$ is open in Y . Since the open (or closed) sets are just the complements of closed (respectively open) subsets, and $g^{-1}(Y - U) = X - g^{-1}(U)$, we see that the continuity of g is equivalent to: if A is closed in X then the pre-image $g^{-1}(A)$ is closed in Y . To prove this, let A be a closed subset of X . Since g is the inverse of f , we have $g^{-1}(A) = f(A)$, hence we have to show that $f(A)$ is closed in Y . Since X is compact, Proposition 4.17 implies that A is compact. By the previous theorem, $f(A)$ must be compact. Since Y is Hausdorff, Theorem 4.18 implies that $f(A)$ is closed in Y . \square

COROLLARY 4.27. *If $f : X \rightarrow Y$ is a continuous injection of a compact space into a Hausdorff one, then f is an embedding.*

EXAMPLE 4.28. Here is an example which shows the use of compactness. We will show that there is no injective continuous map $f : S^1 \rightarrow \mathbb{R}$.

PROOF. Assume there is such a map. Since S^1 is connected and compact, its image is a closed interval $[m, M]$; f becomes a continuous bijection $f : S^1 \rightarrow [m, M]$, hence a homeomorphism (cf. the previous theorem). Then use the “removing a point trick”. \square

EXAMPLE 4.29. (*back to the torus, Moebius band, etc*) In the previous chapter we produced several continuous injective maps without being able to give a simple proof of the fact that they are embeddings: when embedding the abstract torus into \mathbb{R}^n (Example 3.5 in subsection 2), when realizing S^1 as \mathbb{R}/\mathbb{Z} (Example 3.7), or in our examples of cones and suspensions discussed in Example 3.15 (all the references are to the previous chapter). In all these cases, the previous theorem and its corollary immediately complete the proofs.

For clarity, let’s now give a final overview of our discussions on the torus. First, in Chapter 1, Section 6, we introduced the torus intuitively, by gluing the opposite sides of a square. The result was a subspace of \mathbb{R}^3 (or rather a shape). After the definition of topological spaces, we learned that these subspaces of \mathbb{R}^3 are topological spaces on their own- endowed with the induced topology. In the previous chapter, in section 2, we gave a precise meaning to the process of gluing and introduced the abstract torus T_{abs} , endowed with the quotient topology. In the same example we also produced one (of the many possible) continuous injections

$$f : T_{\text{abs}} \rightarrow \mathbb{R}^3$$

whose image was one of the explicit models $T_{R,r} \subset \mathbb{R}^3$ of the torus, described already in the first chapter. Hence the previous corollary implies that f defines a homeomorphism between the abstract T_{abs} and the explicit model $T_{R,r}$.

EXERCISE 4.8. Have a similar discussion for the Moebius band, Klein bottle, etc.

EXERCISE 4.9. Prove that the torus is homeomorphic to $S^1 \times S^1$.

2.5. Embeddings of compact manifolds.

THEOREM 4.30. *Any n -dimensional compact topological manifold can be embedded in \mathbb{R}^N , for some integer N .*

PROOF. We use the Euclidean distance in \mathbb{R}^n and we denote by B_r and \overline{B}_r the resulting open and closed balls of radius r centered at the origin. We choose a function

$$\eta : \mathbb{R}^n \rightarrow [0, 1] \text{ such that } \eta|_{B_1} = 1, \quad \eta|_{\mathbb{R}^n - B_2} = 0.$$

For instance, we could choose

$$\eta(x) = \frac{d(x, \mathbb{R}^n - B_2)}{d(x, \overline{B}_1) + d(x, \mathbb{R}^n - B_2)}.$$

For a coordinate chart

$$\chi : U \rightarrow \mathbb{R}^n$$

and any radius $r > 0$, we consider:

$$U(r) := \chi^{-1}(B_r), \quad U[r] = \overline{U(r)} = \chi^{-1}(\overline{B}_r).$$

Since X is compact, we find a finite number of coordinate charts

$$\chi_i : U_i \rightarrow \mathbb{R}^n, \quad 1 \leq i \leq k,$$

such that $\{U_i(1) : 1 \leq i \leq k\}$ cover X . For each i , consider $\eta \circ \chi_i : U_i \rightarrow [0, 1]$; since it vanishes on $U_i - U_i(2)$, extending it to be 0 outside U_i will give us a continuous map

$$\eta_i : X \rightarrow [0, 1].$$

Similarly, since the product $\eta_i \cdot \chi_i : U_i \rightarrow \mathbb{R}^n$ vanishes on $U_i - U_i(2)$, extending it by 0 gives us continuous maps

$$\tilde{\chi}_i : X \rightarrow \mathbb{R}^n.$$

Finally, we define

$$f = (\eta_1, \dots, \eta_k, \tilde{\chi}_1, \dots, \tilde{\chi}_k) : X \rightarrow \mathbb{R}^{(1+k)n}.$$

It is continuous by construction hence, by Theorem 4.26, it suffices to show that f is injective. Assume that $f(x) = f(y)$ with $x, y \in X$. From the choice of the charts, we find i such that $x \in U_i(1)$. Then $\eta_i(x) = 1$. But $f(x) = f(y)$ implies that $\eta_i(y) = \eta_i(x) = 1$. On one hand, this implies that $\eta_i(y) \neq 0$, hence y must be inside U_i (even inside $U_i(2)$). But these imply

$$\tilde{\chi}_i(x) = \eta_i(x)\chi_i(x) = \chi_i(x)$$

and similarly for y . Finally, $f(x) = f(y)$ also implies that $\tilde{\chi}_i(x) = \tilde{\chi}_i(y)$. Hence x and y are in the domain of χ_i and are sent by χ_i into the same point. Hence $x = y$. \square

COROLLARY 4.31. *Any n -dimensional compact topological manifold is metrizable.*

2.6. Sequential compactness. When one deals with sequences, one often sees statements of type “we now consider a subsequence with this property”. Compactness is related to the existence of convergent subsequences. In general, given a topological space (X, \mathcal{T}) , one says that X is sequentially compact if any sequence $(x_n)_{n \geq 1}$ of elements of X has a convergent subsequence. Recall that a subsequence of $(x_n)_{n \geq 1}$ is a sequence $(y_k)_{k \geq 1}$ of type

$$y_k = x_{n_k}, \text{ with } n_1 < n_2 < n_3 < \dots$$

However, we have already mentioned (and seen in various other cases) that topological properties involving sequences usually require the axiom of first countability.

THEOREM 4.32. *Any first countable compact space is sequentially compact.*

PROOF. Let X be first countable and compact, and assume that $(x_n)_{n \geq 1}$ is an arbitrary sequence in X . For each integer $n \geq 1$ we put

$$U_n = X - \overline{\{x_n, x_{n+1}, \dots\}}.$$

Note that these define an increasing sequence of open subsets of X :

$$U_1 \subset U_2 \subset U_3 \subset \dots$$

We now claim that $\cup_n U_n \neq X$. If this is not the case, $\{U_n : n \geq 1\}$ is an open cover of X hence we find a finite set F such that $\{U_i : i \in F\}$ covers X . Since our cover is increasing, we find that $U_p = X$ where $p = \max F$, and this is clearly impossible. In conclusion, $\cup_n U_n \neq X$. Hence there exists $x \in X$ such that, for all $n \geq 1$, $x \notin U_n$. Choose a countable basis of neighborhoods of x

$$V_1, V_2, V_3, \dots$$

Since $x \notin U_1$, we have $V \cap \{x_1, x_2, \dots\} \neq \emptyset$ for all neighborhoods V of x . Choosing $V = V_1$, we find n_1 such that

$$x_{n_1} \in V_1.$$

Next, we use the fact that $x \notin U_n$ for $n = n_1 + 1$. This means that $V \cap \{x_n, x_{n+1}, \dots\} \neq \emptyset$ for all neighborhoods V of x . Choosing $V = V_2$, we find $n_2 > n_1$ such that

$$x_{n_2} \in V_2.$$

We continue this process inductively (e.g. the next step uses $x \notin U_n$ for $n = n_1 + n_2 + 1$) and we find $n_1 < n_2 < \dots$ such that

$$x_{n_k} \in V_k$$

for all $k \geq 1$. Then $(x_{n_k})_{k \geq 1}$ is a subsequence of $(x_n)_{n \geq 1}$ converging to x . □

COROLLARY 4.33. *Any compact metrizable space is sequentially compact.*

Actually, as we shall see in the next subsection, for metric spaces compactness is equivalent to sequential compactness.

3. Local compactness and the one-point compactification

3.1. Local compactness.

DEFINITION 4.34. A topological space X is called locally compact if any point of X admits a compact neighborhood.

We will be mainly interested in locally compact spaces which are Hausdorff.

EXERCISE 4.10. Prove that, in a locally compact Hausdorff space X , for each $x \in X$ the collection of all compact neighborhoods of x is a basis of neighborhoods of x (i.e. for any open neighborhood U of x , there exists a compact neighborhood N of x such that $N \subset U$).

EXAMPLE 4.35.

1. Any compact Hausdorff space (X, \mathcal{T}) is locally compact Hausdorff.
2. \mathbb{R}^n is locally compact (use closed balls as compact neighborhoods).
3. any open $U \subset \mathbb{R}^n$ is locally compact (use small enough closed balls). In general, any open subset of a locally compact Hausdorff space is locally compact (use the previous exercise).
4. any closed $A \subset \mathbb{R}^n$ is locally compact. Indeed, for any $a \in A$, $B[a, 1] \cap A$ is a neighborhood of a (in A) which is compact (use again that closed inside compact is compact). Similarly, a closed subset of a locally compact Hausdorff space is locally compact.
5. the interval $(0, 1]$ is locally compact (combine the arguments from (2) and (3)).
6. \mathbb{Q} is not locally compact. To show this, assume that 0 has a compact neighborhood N . Then $(-\epsilon, \epsilon) \cap \mathbb{Q} \subset N$, for some $\epsilon > 0$. Passing to closures in \mathbb{R} we find $[-\epsilon, \epsilon] \subset \bar{N} = N$, where we used that N is compact (hence closed). This contradicts $N \subset \mathbb{Q}$.

Locally compact Hausdorff spaces which are 2nd countable deserve special attention: they include topological manifolds and, as we shall see later on, they are easier to handle. The most basic property (to be used several times) is that they can be “exhausted” by compact spaces.

DEFINITION 4.36. Let (X, \mathcal{T}) be a topological space. An *exhaustion* of X is a family $\{K_n : n \in \mathbb{Z}_+\}$ of compact subsets of X such that $X = \cup_n K_n$ and $K_n \subset \overset{\circ}{K}_{n+1}$ for all n .

THEOREM 4.37. Any locally compact, Hausdorff, 2nd countable space admits an exhaustion.

PROOF. Let \mathcal{B} be a countable basis and consider $\mathcal{V} = \{B \in \mathcal{B} : \bar{B} \text{ compact}\}$. Then \mathcal{V} is a basis: for any open U and $x \in X$ we choose a compact neighborhood N inside U ; since \mathcal{B} is a basis, we find $B \in \mathcal{B}$ s.t. $x \in B \subset N$; this implies $\bar{B} \subset N$ and then \bar{B} must be compact; hence we found $B \in \mathcal{V}$ s.t. $x \in B \subset U$. In conclusion, we may assume that we have a basis $\mathcal{V} = \{V_n : n \in \mathbb{Z}_+\}$ where \bar{V}_n is compact for each n . We define the exhaustion $\{K_n\}$ inductively, as follows. We put $K_1 = \bar{V}_1$. Since \mathcal{V} covers the compact K_1 , we find i_1 such that

$$K_1 \subset V_1 \cup V_2 \cup \dots \cup V_{i_1}.$$

Denoting by D_1 the right hand side of the inclusion above, we put

$$K_2 = \bar{D}_1 = \bar{V}_1 \cup \bar{V}_2 \cup \dots \cup \bar{V}_{i_1}.$$

This is compact because it is a finite union of compacts. Since $D_1 \subset K_2$ and D_1 is open, we must have $D_1 \subset \overset{\circ}{K}_2$; since $K_1 \subset D_1$, we have $K_1 \subset \overset{\circ}{K}_2$. Next, we choose $i_2 > i_1$ such that

$$K_2 \subset V_1 \cup V_2 \cup \dots \cup V_{i_2},$$

we denote by D_2 the right hand side of this inclusion, and we put

$$K_3 = \bar{D}_2 = \bar{V}_1 \cup \bar{V}_2 \cup \dots \cup \bar{V}_{i_2}.$$

As before, K_3 is compact, its interior contains D_2 , hence also K_2 . Continuing this process, we construct the family K_n , which clearly covers X . \square

3.2. The one-point compactification. Intuitively, the idea of the one-point compactification of a space is to “add a point at infinity” to achieve compactness.

DEFINITION 4.38. Let (X, \mathcal{T}) be a topological space. A one-point compactification of X is a compact Hausdorff space $(\tilde{X}, \tilde{\mathcal{T}})$ together with an embedding $i : X \rightarrow \tilde{X}$, with the property that $\tilde{X} - X$ consists of one point only.

From the remarks above it follows that, if X admits a one-point compactification, then it must be locally compact and Hausdorff. Conversely, we have:

THEOREM 4.39. If X is a locally compact Hausdorff space, then

1. It admits a one-point compactification X^+ .
2. Any two one-point compactifications of X are homeomorphic.

Moreover, if X is 2nd countable, then so is X^+ .

EXAMPLE 4.40.

1. If $X = (0, 1]$, then X^+ is (homeomorphic to) $[0, 1]$. Indeed, $\tilde{X} = [0, 1]$ is compact, and the inclusion $i : (0, 1] \rightarrow [0, 1]$ satisfies the properties from the previous proposition.
2. If $X = (0, 1)$, then X^+ is (homeomorphic to) the circle S^1 . Indeed, $i : (0, 1) \rightarrow S^1$ as in Figure 3 (e.g. $i(t) = (\cos(2\pi t), \sin(2\pi t))$) has the properties from the previous proposition.

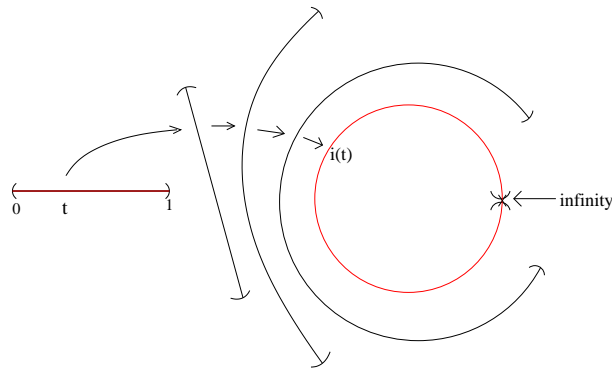

FIGURE 3.

3. If $X = [-1, 0) \cup (1, 2) \subset \mathbb{R}$, X^+ is shown in Figure 4.

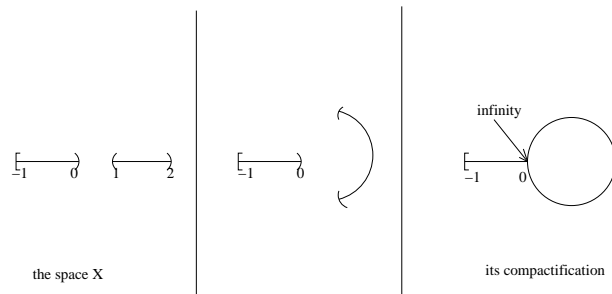

FIGURE 4.

4. If $X = D^{\circ n}$ the one-point compactification is S^n .

PROOF. (of Theorem 4.39) For the existence, choose a symbol $\infty \notin X$ and consider

$$X^+ = X \cup \{\infty\}.$$

Since $X \subset X^+$, any subset of X is a subset of X^+ . We consider the family of subsets of X^+ :

$$\mathcal{T}^+ = \mathcal{T} \cup \mathcal{T}(\infty), \quad \text{where } \mathcal{T}(\infty) = \{X^+ - K : K \subset X, K \text{ compact}\}.$$

We claim that \mathcal{T}^+ is a topology on X^+ . First, we show that $U \cap V \in \mathcal{T}^+$ whenever $U, V \in \mathcal{T}^+$. We have three cases. If $U, V \in \mathcal{T}$, we know that $U \cap V \in \mathcal{T}$. If U and V are both in $\mathcal{T}(\infty)$, then so is their intersection because union of two compacts is compact (show this!). Finally, if $U \in \mathcal{T}$ and $V = X^+ - K \in \mathcal{T}(\infty)$, then $U \cap V = U \cap (X - K)$ is open in X because V and $X - K$ are. Next, we show that arbitrary union of sets from \mathcal{T}^+ is in \mathcal{T}^+ . This property holds for \mathcal{T} , and also for $\mathcal{T}(\infty)$ since intersection of compacts is compact (why?). Hence it suffices to show that $U \cup V \in \mathcal{T}^+$ whenever $U \in \mathcal{T}$, $V \in \mathcal{T}(\infty)$. Writing $V = X^+ - K$ with $K \subset X$ compact, we have

$$U \cup V = X^+ - K',$$

where $K' = K \cap (X - U)$. Since $K - K' = K \cap U$, $K - K'$ is open in K , i.e. K' is closed in the compact K , hence K' is compact (Proposition 4.17 again!). Hence $U \cup V \in \mathcal{T}^+$.

We show that (X^+, \mathcal{T}^+) is compact. Let \mathcal{U} be an open cover of X^+ . Choose $U = X^+ - K \in \mathcal{U}$ containing ∞ and let $\mathcal{U}' = \{V \cap X : V \in \mathcal{U}, V \neq U\}$. Then \mathcal{U}' is an open cover of the compact K in X^+ . Choosing $\mathcal{V} \subset \mathcal{U}'$ finite which covers K , $\mathcal{V} \cup \{U\} \subset \mathcal{U}$ is finite and covers X^+ .

Next, we show that X^+ is Hausdorff. So, let $x, y \in X^+$ distinct, and we are looking for $U, V \in \mathcal{T}^+$ such that $U \cap V = \emptyset$, $x \in U, y \in V$. When $x, y \in X$, just use the Hausdorffness of X . So, let's assume $y = \infty$. Then choose a compact neighborhood K of x and we consider $U \subset X$ open such that $x \in U \subset K$. Then $x \in U$, $\infty \in X - K$ and $U \cap (X^+ - K) = \emptyset$.

Next, we show that the inclusion $i : X \rightarrow X^+$ is an embedding, i.e. that $\mathcal{T}^+|_X = \mathcal{T}$. Now,

$$\mathcal{T}^+|_X = \mathcal{T} \cup \{U \cap X : U \in \mathcal{T}(\infty)\}$$

(just apply the definition!), and just remark that, for $U = X^+ - K \in \mathcal{T}(\infty)$, $U \cap X = X - K \in \mathcal{T}$.

This concludes the proof of 1. For 2, let \tilde{X} be another one-point compactification and we prove that it is homeomorphic to X . Choose $y_\infty \in \tilde{X}$ such that $\tilde{X} = i(X) \cup \{y_\infty\}$ and define

$$f : \tilde{X} \rightarrow X^+, \quad f(y) = \begin{cases} x & \text{if } y = i(x) \in i(X) \\ \infty & \text{if } y = y_\infty \end{cases}$$

Since f is bijective, \tilde{X} is compact and X^+ is Hausdorff, it suffices to show that f is continuous (Theorem 4.26). Let $U \in \mathcal{T}^+$; we prove $f^{-1}(U) \in \tilde{\mathcal{T}}$. If $U \in \mathcal{T}$, then $f^{-1}(U) \subset i(X)$ and then

$$f^{-1}(U) = \{y = i(x) : f(y) \in U\} = \{i(x) : x \in U\} = i(U)$$

is open in $i(X)$ since i is an embedding. But, since \tilde{X} is Hausdorff, $i(X) = \tilde{X} - \{y_\infty\}$ is open in \tilde{X} , hence so is $f^{-1}(U)$. The other case is when $U = X^+ - K$ with $K \subset X$ compact. Then

$$f^{-1}(U) = f^{-1}(y_\infty) \cup f^{-1}(X - K) = \{\infty\} \cup (i(X) - i(K)) = X^+ - i(K)$$

is again open in X^+ ($i(K)$ is compact as the image of a compact by a continuous function).

Finally, we prove the last part of the theorem. Let $\{K_n : n \in \mathbb{Z}_+\}$ be an exhaustion of X , \mathcal{B} a countable basis of X and we claim that the following is a basis of X^+ :

$$\mathcal{B}^+ := \mathcal{B} \cup \mathcal{B}(\infty), \quad \text{where } \mathcal{B}(\infty) = \{X^+ - K_n : n \in \mathbb{Z}_+\}.$$

To show: for any $U \in \mathcal{T}^+$ and any $x \in U$, there exists $B \in \mathcal{B}^+$ such that $x \in B \subset U$. If $U \in \mathcal{T}$, just use that \mathcal{B} is a basis. Similarly, if $U = X^+ - K \in \mathcal{T}(\infty)$, the interesting case is when $x = \infty$. Then we look for $B = X - K_n$ such that $B \subset U$ (i.e. $K \subset K_n$). But $\{\overset{\circ}{K}_n\}$ is an open cover of X , hence also of K ; since K is compact and $K_n \subset K_{n+1}$, we find n such that $K \subset \overset{\circ}{K}_n$. \square

4. More exercises

4.1. Connectedness.

EXERCISE 4.11. In Exercise 1.4 you showed that four of the spaces in the picture are homeomorphic to each other, but they did not seem to be homeomorphic to the fifth one. You now have the tool to prove the last assertion (so do it!).

EXERCISE 4.12. Prove that the following spaces are not homeomorphic:

1. S^1 and $[0, 1)$.
2. $[0, 1)$ and \mathbb{R} .
3. S^1 and S^2 .
4. S^1 and a bouquet of two circles (the space from Figure 5).

EXERCISE 4.13. Show that there exists a real number $r \in (2, 3)$ such that

$$r^7 - 2r^4 - r^2 - 2r = 2011.$$

EXERCISE 4.14. Show that any continuous function $f : [0, 1] \rightarrow [0, 1]$ admits at least one fixed point (i.e. there exists $t \in [0, 1]$ such that $f(t) = t$).

(Hint: $g(t) = f(t) - t$ positive or negative?)

EXERCISE 4.15. Assuming that the temperature on the surface of the earth is a continuous function, prove that, at any moment in time, on any great circle of the earth, there are two antipodal points with the same temperature.

EXERCISE 4.16. Assuming that you know that $S^1 \times (0, 1)$ is not homeomorphic to \mathbb{R}^2 , show that the sphere S^2 is not homeomorphic to the space obtained from S^2 by gluing two antipodal points.

EXERCISE 4.17. Is $(\mathbb{R}, \mathcal{T}_l)$ from Exercise 2.19 connected? But $[0, 1)$ with the induced topology? But $(0, 1]$?

EXERCISE 4.18. Recall that by a circle we mean any topological space which is homeomorphic to S^1 , and by a circle embedded in a topological space X we mean any subset $A \subset X$ which, when endowed with the induced topology, is a circle. Similarly, by a bouquet of two circles we mean any space which is homeomorphic to the space drawn in Figure 5, and we talk about embedded bouquets of circles. Let T be a torus.

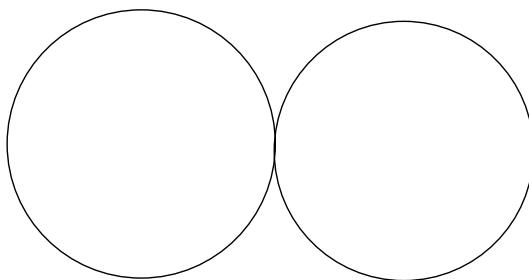

FIGURE 5.

1. Describe a circle C embedded in T such that the complement of $T - C$ is connected.
2. Describe a bouquet of two circles B embedded in T such that $T - B$ is connected.

EXERCISE 4.19. Show that the group $GL_n(\mathbb{R})$ of $n \times n$ invertible matrices with real coefficients (see Exercise 2.33) is not connected.

EXERCISE 4.20. Show that any two of the three spaces drawn in Figure 6 are not homeomorphic.

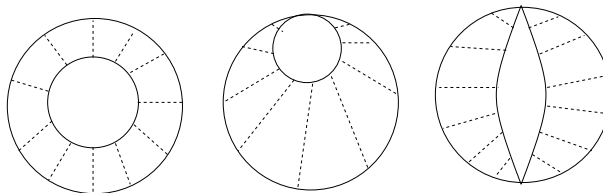

FIGURE 6.

EXERCISE 4.21. Prove that if $X \subset \mathbb{R}^n$ is connected then its closure is also connected but its interior may fail to be connected.

EXERCISE 4.22. Show that the cone of any space is connected.

EXERCISE 4.23. For a topological space (X, \mathcal{T}) , show that the following are equivalent:

- (1) X is connected.
- (2) \emptyset and X are the only subsets of X which are both open and closed.
- (3) the only continuous functions $f : X \rightarrow \{0, 1\}$ are the constant ones (where $\{0, 1\}$ is endowed with the discrete topology).

EXERCISE 4.24. Prove that if X and Y are homeomorphic, then they have the same number of connected components.

4.2. Compactness.

EXERCISE 4.25. Assume that X is a topological space and $(x_n)_{n \geq 1}$ is a sequence in X , convergent to $x \in X$. Show that

$$A = \{x, x_1, x_2, x_3, \dots\}$$

is compact.

EXERCISE 4.26. Let \mathcal{T}_l be the topology from Exercise 2.19. With the topology induced from $(\mathbb{R}, \mathcal{T}_l)$ is $[0, 1)$ compact? But $[0, 1]$?

EXERCISE 4.27. Let (X, \mathcal{T}) be a Hausdorff space, $A, B \subset X$. If A and B are compact, show that $A \cap B$ is compact. Is the Hausdorffness assumption on X essential?

EXERCISE 4.28. Let X be a topological space and $A, B \subset X$. If A and B are compact, show that $A \cup B$ is compact.

EXERCISE 4.29. Given a set X , when is (X, \mathcal{T}_{cf}) compact?

EXERCISE 4.30. Show that the sequence $x_n = 2011^{\sin(5n)}$ (in \mathbb{R} with the Euclidean topology) has a convergent subsequence.

EXERCISE 4.31. Recall that the graph of a function $f : \mathbb{R} \rightarrow \mathbb{R}$ is

$$Gr(f) = \{(x, f(x)) : x \in \mathbb{R}\} \subset \mathbb{R}^2.$$

If f is bounded, show that f is continuous if and only if $Gr(f)$ is closed in \mathbb{R}^2 . What if f is not bounded.

(hint: for the first part, use sequences; for the last part: $1/x$).

EXERCISE 4.32. Find a topological space (X, \mathcal{T}) which is compact but is not Hausdorff. In the example that you found, exhibit a compact set $A \subset X$ such that A is not closed.

EXERCISE 4.33. Find an example which shows that the Tube Lemma fails if Y is not compact.

EXERCISE 4.34. Let (X, \mathcal{T}) be a second countable topological space. Show that X is compact if and only if for any decreasing sequence of nonempty closed subsets

$$\dots \subset F_3 \subset F_2 \subset F_1 \subset X,$$

one has $\bigcap_{n=1}^{\infty} F_n \neq \emptyset$.

(Hint: restate the property in terms of opens; then try to use Exercise 2.63).

EXERCISE 4.35. If X is a Hausdorff space, and $A \subset X$ is compact, show that the quotient X/A (obtained from X by collapsing A to a point) is Hausdorff.

EXERCISE 4.36. Show that \mathbb{P}^2 can be embedded in \mathbb{R}^4 (see Exercise 1.22 in the first chapter). Then do again Exercise 3.3 from Chapter 3.

EXERCISE 4.37. Show that the cone and the suspension of any compact topological space are compact.

EXERCISE 4.38. If X is connected and compact and $f : X \rightarrow \mathbb{R}$ is continuous, show that $f(X) = [m, M]$ for some $m, M \in \mathbb{R}$.

EXERCISE 4.39.

- (i) Is it true that any continuous surjective map $f : S^1 \rightarrow S^1$ is a homeomorphism?
- (ii) Show that S^1 cannot be embedded in \mathbb{R} .
- (iii) Show that any continuous injective map $f : S^1 \rightarrow S^1$ is a homeomorphism.

4.3. Local compactness and the one-point compactification.

EXERCISE 4.40. What is the one-point compactification of $X = (0, 1) \cup (2, 3)$?

EXERCISE 4.41. What is the one-point compactification of \mathbb{R}^2 ?

EXERCISE 4.42. Show that the following subspace of \mathbb{R}^2 is locally compact and find its one-point compactification:

$$X = S^1 \cup ((0, 2) \times \{0\}) \subset \mathbb{R}^2.$$

EXERCISE 4.43. Show that, for any circle C embedded in the Klein bottle K , $K - C$ is locally compact. Then describe such a circle C such that $(K - C)^+$ is homeomorphic to \mathbb{P}^2 .

EXERCISE 4.44. Show that there exists a Hausdorff space X and an embedded circle C in X , such that the one-point compactification of $X - C$ is homeomorphic to X .

EXERCISE 4.45. Consider

$$X = [0, 1] \times [0, 1]$$

with the topology induced from \mathbb{R}^2 . Prove that X is a locally compact Hausdorff space and describe its one-point compactification (use a picture). What happens if we replace X by $Y = X \cup \{(1, 1)\}$?

EXERCISE 4.46. For any continuous map $f : S^1 \rightarrow T^2$ we define

$$X_f := T^2 - f(S^1).$$

- (i) Is it true that, for any continuous function f , X_f is compact? But locally compact? But metrizable? But connected?
- (ii) Describe two embeddings $f_1, f_2 : S^1 \rightarrow T^2$ such that X_{f_1} and X_{f_2} are not homeomorphic.

(iii) Describe the one-point compactifications $X_{f_1}^+$ and $X_{f_2}^+$.

(iv) Describe $f : S^1 \rightarrow T^2$ continuous such that X_f^+ is homeomorphic to S^2 .

EXERCISE 4.47. Describe an embedding of the cylinder $S^1 \times [0, 1]$ into the space X , show that its complement is locally compact, and find the one-point compactification of the complement, in each of the cases:

(i) X is a torus.

(ii) X is the plane \mathbb{R}^2 .

EXERCISE 4.48. Let X be a connected, locally compact, Hausdorff space. Show that X is compact if and only if X^+ is not connected.

EXERCISE 4.49. Let X be a Hausdorff compact space and $A \subset X$ be a closed subset. Show that

1. $X - A$ is locally compact.
2. X/A is compact and Hausdorff.
3. X/A is (homeomorphic to) the one-point compactification of $X - A$.

CHAPTER 5

Partitions of unity

1. Some axioms for sets of functions
2. Finite partitions of unity
3. Arbitrary partitions of unity
4. The locally compact case
5. Urysohn's lemma
6. More exercises

1. Some axioms for sets of functions

The theory of “partitions of unity” is the most important tool that allows one to pass “from local to global”. As such, it is widely used in many fields of mathematics, most notably in many branches of Geometry and Analysis. The word “unity” stands for the constant function equal to 1, on some given space X . A “partition of unity” is a decomposition

$$\sum_i \eta_i = 1$$

of the constant function into a sum of continuous functions η_i . One is interested in such partitions of unity with the extra-requirement that each η_i is “concentrated in a given (usually very small) open U_i ”. The U_i ’s form a (given) open cover of X and one is interested in the existence of partitions of unity “subordinated” to the cover.

Let us also mention that, when it comes to applications to Geometry and Analysis, one deals with topological spaces that have extra-structure and the “partitions of unity” are required to be more than continuous (in most cases one can talk about differentiable functions, and the partitions are required to be so). Ironically, the existence of such “special” partitions of unity is easier to establish than the existence of the continuous partitions for general topological spaces. To include such applications, we will include in our discussion a given set \mathcal{A} of continuous functions. To specify the axioms for \mathcal{A} , we consider the space of continuous functions on X :

$$\mathcal{C}(X) = \mathcal{C}(X, \mathbb{R}) = \{f : X \rightarrow \mathbb{R} : f \text{ is continuous}\}.$$

We use some of the structure present on $\mathcal{C}(X)$. First, we can take sums of continuous functions:

$$(f + g)(x) = f(x) + g(x).$$

Secondly, we can take quotients f/g , whenever g is nowhere vanishing:

$$\frac{f}{g}(x) := \frac{f(x)}{g(x)},$$

DEFINITION 5.1. *Given a topological space X , we say that a subset $\mathcal{A} \subset \mathcal{C}(X)$:*

- *is closed under finite sums if $f + g \in \mathcal{A}$ whenever $f, g \in \mathcal{A}$.*
- *is closed under quotients if $f/g \in \mathcal{A}$ whenever $f, g \in \mathcal{A}$ and g is nowhere vanishing.*

There are more operations that we can perform on $\mathcal{C}(X)$ - multiplication by real numbers, or multiplication of continuous functions; in examples, \mathcal{A} is usually closed under all these operations. However, the most important condition on \mathcal{A} is the following topological one:

DEFINITION 5.2. *Given a topological space X and $\mathcal{A} \subset \mathcal{C}(X)$, we say that \mathcal{A} is normal if for any two closed disjoint subsets $A, B \subset X$, there exists $f : X \rightarrow [0, 1]$ which belongs to \mathcal{A} and such that $f|_A = 0$, $f|_B = 1$.*

As we remarked in Section 6 of Chapter 2, the existence of such continuous functions implies that X must be normal: any two closed disjoint subsets $A, B \subset X$ can be separated topologically. In what follows we will repeatedly make use of the following:

LEMMA 5.3. *In a normal space X , if $A \subset U \subset X$ with A -closed and U -open in X , then there exists an open V in X such that $A \subset V \subset \overline{V} \subset U$.*

PROOF. Since $A \subset U$, A and $X - U$ are disjoint. They are both closed, hence we know that we can find disjoint opens W and V such that $A \subset V$, $X - U \subset W$. The condition $V \cap W = \emptyset$ is equivalent to $V \subset X - W$. Since $X - W$ is a closed containing V , this implies $\overline{V} \subset X - W$. On the other hand, $X - U \subset W$ can be re-written as $X - W \subset U$. Hence $\overline{V} \subset X - W \subset U$. \square

2. Finite partitions of unity

In this section we give a precise meaning to the statement that a continuous function $\eta : X \rightarrow \mathbb{R}$ is “concentrated” in an open $U \subset X$. We will use the notation:

$$\{f \neq 0\} := \{x \in X : f(x) \neq 0\}.$$

DEFINITION 5.4. Given a topological space X and $\eta : X \rightarrow \mathbb{R}$, define the support of η as

$$\text{supp}(\eta) := \overline{\{f \neq 0\}} \subset X.$$

We say that η is supported in an open U if $\text{supp}(\eta) \subset U$.

It is important that the support is defined as the closure of $\{f \neq 0\}$. This condition allows us to perform “globalization”, as the following exercise indicates.

EXERCISE 5.1. Let (X, \mathcal{T}) be a topological space, $U \subset X$ open and $\eta \in \mathcal{C}(X)$ supported in U . Then, for any continuous map $g : U \rightarrow \mathbb{R}$,

$$(\eta \cdot g) : X \rightarrow \mathbb{R}, \quad (\eta \cdot g)(x) = \begin{cases} \eta(x)g(x) & \text{if } x \in U \\ 0 & \text{if } x \notin U \end{cases}.$$

is continuous. Show that this statement fails if we only assume that $\{f \neq 0\} \subset U$.

Next we discuss finite partitions of unity.

DEFINITION 5.5. Let X be a topological space, $\mathcal{U} = \{U_1, \dots, U_n\}$ a finite open cover of X . A partition of unity subordinated to \mathcal{U} is a family of functions $\eta_i : X \rightarrow [0, 1]$ satisfying:

$$\eta_1 + \dots + \eta_n = 1, \quad \text{supp}(\eta_i) \subset U_i.$$

Given $\mathcal{A} \subset \mathcal{C}(X)$, we say that $\{\eta_i\}$ is an \mathcal{A} -partition of unity if $\eta_i \in \mathcal{A}$ for all i .

EXERCISE 5.2. Show that, given $\mathcal{A} \subset \mathcal{C}(X)$, the following are equivalent:

1. any 2-open cover $\mathcal{U} = \{U_1, U_2\}$ admits an \mathcal{A} -partition of unity subordinated to it.
2. \mathcal{A} separates the closed subsets of X .

THEOREM 5.6. Let X be a topological space and assume that $\mathcal{A} \subset \mathcal{C}(X)$ is normal and closed under finite sums and quotients.

Then, for any finite open cover \mathcal{U} , there exists an \mathcal{A} -partition of unity subordinated to \mathcal{U} .

PROOF. The main topological ingredient in the proof is the following “shrinking lemma”.

LEMMA 5.7. (the finite shrinking lemma) For any finite open covering $\mathcal{U} = \{U_i : 1 \leq i \leq n\}$ of a normal space X , there exists a covering $\mathcal{V} = \{V_i : 1 \leq i \leq n\}$ such that

$$\overline{V_i} \subset U_i, \quad \forall i = 1, \dots, n.$$

PROOF. Let

$$A = X - (U_2 \cup \dots \cup U_n), D = U_1.$$

Then A is closed, D is open, and $A \subset D$. By Lemma 5.3 from the end of Chapter 2, we find V_1 open such that

$$A \subset V_1 \subset \overline{V_1} \subset D (= U_1).$$

This means that

$$\{V_1, U_2, \dots, U_n\}$$

is a new open cover of X with $\overline{V_1} \subset U_1$. In other words, we have managed to “refine U_1 ”. Applying the same argument to this new cover (to refine U_2), we find a new open cover

$$\{V_1, V_2, U_3, \dots, U_n\}$$

with $\overline{V_1} \subset U_1, \overline{V_2} \subset U_2$. Continuing this argument, we obtain the desired open cover \mathcal{V} . \square

We now prove the theorem. Let $\mathcal{U} = \{U_i\}$ be the given finite open cover. Apply the previous lemma twice and choose open covers $\mathcal{V} = \{V_i\}$, $\mathcal{W} = \{W_i\}$, with $\overline{V}_i \subset U_i$, $\overline{W}_i \subset V_i$. For each i , we use the separation property of \mathcal{A} for the disjoint closed sets $(\overline{W}_i, X - V_i)$. We find $f_i : X \rightarrow [0, 1]$ that belongs to \mathcal{A} , with $f_i = 1$ on \overline{W}_i and $f_i = 0$ outside V_i . Note that

$$f := f_1 + \dots + f_n$$

is nowhere zero. Indeed, if $f(x) = 0$, we must have $f_i(x) = 0$ for all i , hence, for all i , $x \notin W_i$. But this contradicts the fact that \mathcal{W} is a cover of X . From the properties of \mathcal{A} , each

$$\eta_i := \frac{f_i}{f_1 + \dots + f_n} : X \rightarrow [0, 1]$$

is continuous. Clearly, their sum is 1. Finally, $\text{supp}(\eta_i) \subset U_i$ because $\overline{V}_i \subset U_i$ and $\{x : \eta_i(x) \neq 0\} = \{x : f_i(x) \neq 0\} \subset V_i$. \square

3. Arbitrary partitions of unity

For arbitrary partitions of unity one has to deal with infinite sums $\sum_i f_i$ of continuous functions on X (indexed by some infinite set I). In such cases it is natural to require that, for each $x \in X$, the sum $\sum_i f_i(x)$ is finite (i.e. $f_i(x) = 0$ for all but a finite number of i 's). Although the sum is then well defined as a function on X , to retain continuity, a slightly stronger notion is needed.

DEFINITION 5.8. *Let (X, \mathcal{T}) be a topological space and let $\mathcal{S} = \{S_i\}$ be a family of subsets of X . We say that \mathcal{S} is locally finite (in the space X) if for any $x \in X$, there exists a neighborhood V_x of x such that V_x intersects only finitely many subsets that belong to \mathcal{S} .*

EXAMPLE 5.9. The collection $\mathcal{S} = \{(0, 1/n) : n \in \mathbb{Z}\}$ is locally finite in $(0, 1)$, but not in \mathbb{R} .

DEFINITION 5.10. *Given a topological space X , a family $\{\tilde{g}_i : i \in I\}$ of continuous functions $\tilde{g}_i : X \rightarrow \mathbb{R}$ is called a locally finite family of continuous functions if $\{\text{supp}_X(\tilde{g}_i) : i \in I\}$ is locally finite.*

EXERCISE 5.3. Show that if $\{\tilde{g}_i : i \in I\}$ is a locally finite family of continuous functions, then

$$X \ni x \mapsto \sum_i \tilde{g}_i(x)$$

gives a well-defined continuous function $\sum_i g_i : X \rightarrow \mathbb{R}$.

DEFINITION 5.11. *Given a topological space X and $\mathcal{A} \subset \mathcal{C}(X)$, we say that \mathcal{A} is closed under locally finite sums if for any locally finite family $\{\tilde{g}_i : i \in I\}$ of functions from \mathcal{A} , $\sum f_i \in \mathcal{A}$.*

DEFINITION 5.12. *Let X be a topological space, $\mathcal{U} = \{U_i : i \in I\}$ an open cover of X . A partition of unity subordinated to \mathcal{U} is a locally finite family of functions $\eta_i : X \rightarrow [0, 1]$ satisfying:*

$$\sum_i \eta_i = 1, \quad \text{supp}(\eta_i) \subset U_i.$$

Given $\mathcal{A} \subset \mathcal{C}(X)$, we say that $\{\eta_i\}$ is an \mathcal{A} -partition of unity if $\eta_i \in \mathcal{A}$ for all i .

The existence of partitions of unity (for arbitrary covers) forces X to have a special topological property, called “paracompactness”, which we discuss next. As in the case of compactness, paracompactness is best characterized in terms of open covers.

DEFINITION 5.13. *Let X be a topological space and let \mathcal{A} be a cover of X . A refinement of \mathcal{A} is any other cover \mathcal{B} with the property that any $B \in \mathcal{B}$ is contained in some $A \in \mathcal{A}$.*

EXAMPLE 5.14. For $X = \mathbb{R}$ and $\mathcal{A} = \{(0, \epsilon) : \epsilon \in (0, 1)\}$, $\mathcal{B} = \{(0, 1/n) : n \in \mathbb{Z}_+\}$, \mathcal{B} is subcover (hence also a refinement) of \mathcal{A} but, at the same time, \mathcal{A} is a refinement of \mathcal{B} .

As a motivation for the next definition, note that if $\{\eta_i\}$ is a partition of unity subordinated to \mathcal{U} , then $\{\eta_i \neq 0\}$ is an open refinement of \mathcal{U} (which still covers X !), which is locally finite.

DEFINITION 5.15. *A topological space X is called paracompact if any open cover admits a locally finite refinement.*

EXAMPLE 5.16. Compact spaces are paracompact (use again that any subcover is a refinement). As we will prove in the next section, any locally compact, Hausdorff, 2nd countable space (hence also any topological manifold) is paracompact. One can also show that all metric spaces are paracompact. Hence paracompactness is shared by the most important classes of spaces.

As in the previous subsection, for partitions of unity, we will need a “shrinking lemma”.

LEMMA 5.17. (*shrinking lemma*) *If X is a paracompact Hausdorff space then X is normal and, for any open cover $\mathcal{U} = \{U_i : i \in I\}$ there exists a locally finite open cover $\mathcal{V} = \{V_i : i \in I\}$ with the property that $\overline{V}_i \subset U_i$ for all $i \in I$.*

PROOF. We first show that X is normal. The proof is very similar to the compact case, i.e. the proof of Proposition 4.19. We use the same idea and the same notations. We see that it suffices to show that, for $Y, Z \subset X$, if Z is closed and $Y \cap \{z\} = \emptyset$ for all $z \in Z$, then $Y \cap Z = \emptyset$. To prove this, we first make a general remark: the condition $Y \cap \{z\} = \emptyset$ implies (and it is actually equivalent to) the existence of an open neighborhood V of Z such that $Y \cap \overline{V} = \emptyset$. Indeed, if $U \cap V = \emptyset$ for some open neighborhoods U of Y and V of Z , then $V \subset X - U$ where the last set is closed, hence $\overline{V} \subset X - U$, hence $\overline{V} \cap U = \emptyset$; since $Y \subset U$, we must have $\overline{V} \cap Y = \emptyset$ (for the converse, just take $U = X - \overline{V}$).

Hence we assume now that $Y \cap \{z\} = \emptyset$ for all $z \in Z$ and we prove $Y \cap Z = \emptyset$. For each $z \in Z$ choose an open neighborhood V_z such that $Y \cap \overline{V}_z = \emptyset$. Then $\{V_z : z \in Z\} \cup \{X - Z\}$ is an open cover of X . Let \mathcal{U} be a locally finite refinement and let $\mathcal{W} = \{W_i : i \in I\}$ consisting of those members of \mathcal{U} which intersect Z . Define $V = \cup_i W_i$. This is an open neighborhood of Z . Note that $Y \cap \overline{W}_i = \emptyset$ for all i (since each W_i is inside some V_z and $Y \cap \overline{V}_z = \emptyset$ by construction). Also, due to local finiteness (and Exercise 2.53),

$$\overline{V} = \cup_i \overline{W}_i.$$

Hence $\overline{V} \cap Y = \emptyset$, proving that $Y \cap Z = \emptyset$. In conclusion X must be normal.

We now prove the second part. Consider $\mathcal{A} := \{V \subset X \text{ open} : \overline{V} \subset U_i \text{ for some } i \in I\}$. Since X is normal, Lemma 5.3 implies that \mathcal{A} is an open cover of X . Let $\mathcal{B} = \{B_j : j \in J\}$ be a locally finite refinement of \mathcal{A} which is an open cover of X . Then, for each $j \in J$, we find an element $f(j) \in I$ such that $\overline{B}_j \subset U_{f(j)}$ (and this defines a function $f : J \rightarrow I$). We define

$$V_i := \cup_{j \in f^{-1}(i)} B_j$$

(by convention, this is empty if $f^{-1}(i)$ is empty). Using Exercise 2.53, we have $\overline{V}_i \subset U_i$ for all i . Finally, remark that $\{V_i\}$ is locally finite: if a neighborhood of a point intersects V_i then it intersects B_j for some $j \in f^{-1}(i)$, hence it intersects an infinite number of V_i 's, then it would also intersect an infinite number of B_j 's. \square

THEOREM 5.18. *Let X be a paracompact Hausdorff space and assume that $\mathcal{A} \subset \mathcal{C}(X)$ is normal, closed under locally finite sums and closed under quotients.*

Then, for any open cover \mathcal{U} of X , there exists an \mathcal{A} -partition of unity subordinated to \mathcal{U} .

PROOF. The proof is completely similar to the proof from the finite case. Apply the shrinking lemma twice to find coverings $\{V_i\}$ and $\{W_i\}$ with $\overline{V}_i \subset U_i$, $\overline{W}_i \subset V_i$. Then choose $\phi_i : X \rightarrow [0, 1]$ such that $\phi_i = 1$ on \overline{W}_i and 0 on $X - V_i$, with $\phi_i \in \mathcal{A}$. Finally, since our families are locally finite, $\eta_i = \phi_i / \sum_j \phi_j$ makes sense and is our desired partition of unity (fill in the details!). \square

4. The locally compact case

The locally compact Hausdorff case is nicer. First of all the condition on $\mathcal{A} \subset \mathcal{C}(X)$ to separate the closed subsets of X (which may be difficult to prove!) can be reduced to a local condition.

THEOREM 5.19. *Let X be a Hausdorff paracompact space and $\mathcal{A} \subset \mathcal{C}(X)$ closed under locally finite sums and under quotients. If X is also locally compact, then the following are equivalent:*

1. \mathcal{A} is normal.
2. $\forall (x \in U \subset X \text{ with } U \text{ open}), \exists (f \in \mathcal{A} \text{ positive, supported in } U, \text{ with } f(x) > 0)$.

Secondly, 2nd countability and local compactness imply paracompactness:

THEOREM 5.20. *Any Hausdorff, locally compact and 2nd countable space is paracompact.*

PROOF. (of Theorem 5.20) We use an exhaustion $\{K_n\}$ of X (Theorem 4.37). Let \mathcal{U} be an open cover of X . For each $n \in \mathbb{Z}_+$ there is a finite family \mathcal{V}_n which covers $K_n - \text{Int}(K_{n-1})$, consisting of opens V with the properties: $V \subset \text{Int}(K_{n+1}) - K_{n-1}$, $V \subset U$ for some $U \in \mathcal{U}$. Indeed, for any $x \in K_n - \text{Int}(K_{n-1})$ let V_x be the intersection of $\text{Int}(K_{n+1}) - K_{n-1}$ with any member of \mathcal{U} containing x ; since $K_n - \text{Int}(K_{n-1})$ is compact, just take a finite subcollection \mathcal{V}_n of $\{V_x\}$, covering $K_n - \text{Int}(K_{n-1})$. Set $\mathcal{V} = \cup_n \mathcal{V}_n$; it covers X since each $K_n - K_{n-1} \subset K_n - \text{Int}(K_{n-1})$ is covered by \mathcal{V}_n . Finally, it is locally finite: if $x \in X$, choosing n and V such that $V \in \mathcal{V}_n$, $x \in V$, we have $V \subset \text{Int}(K_{n+1}) - K_{n-1}$, hence V can only intersect members of \mathcal{V}_m with $m \leq n + 1$ (a finite number of them!). \square

PROOF. (of Theorem 5.19) That 1 implies 2 is clear: apply the separation property to $\{x\}$ and $X - V$. Assume 2. We claim that for any $C \subset X$ compact and any open U such that $C \subset U$, there exists $f \in \mathcal{A}$ supported in U , such that $f|_C > 0$. Indeed, by hypothesis, for any $c \in C$ we can find an open neighborhood V_c of c and $f_c \in \mathcal{A}$ positive such that $f_c(c) > 0$; then $\{f_c \neq 0\}_{c \in C}$ is an open cover of C in X , hence we can find a finite subcollection (corresponding to some points $c_1, \dots, c_k \in C$) which still covers C ; finally, set $f = f_{c_1} + \dots + f_{c_k}$.

To prove 1, let $A, B \subset X$ be two closed disjoint subsets. As terminology, $D \subset X$ is called relatively compact if \bar{D} is compact. Since X is locally compact, any point has arbitrarily small relatively compact open neighborhoods (why?). For each $y \in X - A$, we choose such a neighborhood $D_y \subset X - A$. For each $a \in A$, since $a \in X - B$, by Lemma 5.17 and Lemma 5.3, we find an open D_a such that $a \in D_a \subset X - B$. Again, we may assume that \bar{D}_a is relatively compact. Then $\{D_x : x \in X\}$ is an open cover of X ; let $\mathcal{U} = \{U_i : i \in I\}$ be a locally finite refinement. We split the set of indices as $I = I_1 \cup I_2$, where I_1 contains those i for which $U_i \cap A \neq \emptyset$, while I_2 those for which $U_i \subset X - A$. Using Lemma 5.17 we also choose an open cover of X , $\mathcal{V} = \{V_i : i \in I\}$, with $\bar{V}_i \subset U_i$. Note that, by construction, each U_i (hence also each V_i) is relatively compact. Hence, by the claim above, we can find $\eta_i \in \mathcal{A}$ such that

$$\eta_i|_{\bar{V}_i} > 0, \quad \text{supp}(\eta_i) \subset U_i.$$

Finally, we define

$$f(x) = \frac{\sum_{i \in I_1} \eta_i(x)}{\sum_{i \in I} \eta_i(x)}$$

From the properties of \mathcal{A} , $f \in \mathcal{A}$. Also, $f|_A = 1$. Indeed, for $a \in A$, a cannot belong to the U_i 's with $i \in I_2$ (i.e. those $\subset X - A$); hence $\eta_i(a) = 0$ for all $i \in I_2$, hence $f(a) = 1$. Finally, $f|_B = 0$. To see this, we show that $\eta_i(b) = 0$ for all $i \in I_1$, $b \in B$. Assume the contrary. We find $i \in I_1$ and $b \in B \cap U_i$. Now, from the construction of \mathcal{U} , $U_i \subset D_x$ for some $x \in X$. There are two cases. If $x = a \in A$, then the defining property for D_a , namely $D_a \cap B = \emptyset$, is in contradiction with our assumption ($b \in B \cap U_i$). If $x = y \in X - A$, then the defining property for D_y , i.e. $D_y \subset X - A$, is in contradiction with the fact that $i \in I_1$ (i.e. $U_i \cap A \neq \emptyset$). \square

5. Urysohn's lemma

This section is devoted to the proof of what is known as “the Urysohn lemma”:

THEOREM 5.21. *If X is a normal space then for any two closed disjoint subsets $A, B \subset X$, there exists a continuous function $f : X \rightarrow [0, 1]$ such that $f|_A = 0$, $f|_B = 1$.*

In other words, if X is normal, then $\mathcal{C}(X)$ is normal. Hence one can construct continuous partitions of unity.

COROLLARY 5.22. *If X is Hausdorff and paracompact then, for any open cover \mathcal{U} of X , there exists a continuous partition of unity subordinated to \mathcal{U} .*

We start with the proof. Fix A and B disjoint closed subsets. From now on, when saying that “ A is closed” or “ D is open”, we mean that they are closed (open) in the given topological space (X, \mathcal{T}) . We will repeatedly use Lemma 5.3 from this chapter.

Claim 1: Then there is a family of opens sets $\{U_q : q \in \mathbb{Q}\}$ such that

(C1) $U_q = \emptyset$ for $q < 0$, U_0 contains A , $U_1 = X - B$, $U_q = X$ for $q > 1$.

(C2) $\overline{U}_q \subset U_{q'}$ for all $q < q'$.

PROOF. The condition (C1) force the definition of U_q for $q < 0$ and for $q \geq 1$. For $q = 0$, we choose U_0 to be any open set such that

$$A \subset U_0 \subset \overline{U}_0 \subset U_1.$$

This is possible since $A \cap B = \emptyset$ means that $A \subset X - B = U_1$ hence we can apply Lemma 5.3.

We are left with the construction of U_q for $q \in \mathbb{Q} \cap (0, 1)$. Writing

$$\mathbb{Q} \cap [0, 1] = \{q_0, q_1, q_2, \dots\},$$

with $q_0 = 0$, $q_1 = 1$, we will define U_{q_n} by induction on n such that (C2) holds for all $q = q_i$, $q' = q_j$ with $0 \leq i, j \leq n$. Assume that U_q is constructed for $q \in \{q_0, \dots, q_n\}$ and we construct it for $q = q_{n+1}$. Looking at all intervals of type (q_i, q_j) with $0 \leq i, j \leq n$, there is a smallest one containing q_{n+1} . Call it (q_a, q_b) . Since $q_a < q_b$, by the induction hypothesis we have

$$\overline{U}_a \subset U_b$$

hence, by Lemma 5.3, we find an open U such that

$$\overline{U}_a \subset U \subset \overline{U} \subset U_b.$$

Define $U_{q_{n+1}} = U$. We have to check that (C2) holds for $q, q' \in \{q_0, \dots, q_{n+1}\}$. Fix q, q' . If $q \neq q_{n+1}$ and $q' \neq q_{n+1}$, $\overline{U}_q \subset U_{q'}$ holds by the induction hypothesis. Hence we may assume that $q = q_{n+1}$ or $q' = q_{n+1}$. We treat the case $q = q_{n+1}$, the other one being similar. Write $q' = q_j$ with $j \in \{0, 1, \dots, n\}$. The assumption is that $q_{n+1} < q_j$ and we want to show that

$$\overline{U}_{q_{n+1}} \subset U_{q_j}.$$

But, since $q_{n+1} < q_j$ and (q_a, q_b) is the smallest interval of this type containing q_{n+1} , we must have $q_j \geq q_b$. But then

$$\overline{U}_{q_{n+1}} = \overline{U} \subset U_{q_b} \subset U_{q_j}.$$

□

Claim 2: The function $f : X \rightarrow [0, 1]$, $f(x) = \inf\{q \in \mathbb{Q} : x \in U_q\}$ satisfies:

(1) $f(x) > q \implies x \notin \overline{U}_q$.

(2) $f(x) < q \implies x \in U_q$.

(in particular, $f(x) = q$ for $x \in \partial U_q$).

PROOF. For (1), we prove its negation, i.e. that $x \in \overline{U}_q$ implies $f(x) \leq q$. Hence assume that $x \in \overline{U}_q$. From (C2) we deduce that $x \in U_{q'}$ for all $q' > q$. Hence $f(x) \leq q'$ for all $q' > q$. This implies $f(x) \leq q$. For (2), we assume that $f(x) < q$. By the definition of $f(x)$ (as an infimum), there exists $q' < q$ such that $x \in U_{q'}$. But $q' < q$ implies $U_{q'} \subset U_q$, hence $x \in U_q$. \square

Claim 3: $f|_A = 0$, $f|_B = 1$, and f is continuous.

PROOF. The first two conditions are immediate from the definition of f and properties (C1) of the first claim. We now prove that f is continuous. We have to prove that for any open interval (a, b) in \mathbb{R} , and any $x \in f^{-1}((a, b))$, there exists an open U containing x such that $f(U) \subset (a, b)$. Fix (a, b) and x such that $f(x) \in (a, b)$ and look for U satisfying the desired condition. Choosing $p, q \in \mathbb{Q}$ such that

$$a < p < f(x) < q < b,$$

then $U := U_q - \overline{U}_p$ will do the job. Indeed:

1. using Claim 2, $f(x) > p$ implies $x \notin \overline{U}_p$, while $f(x) < q$ implies $x \in U_q$. Hence $x \in U$.
2. for $y \in U$ arbitrary, we have $f(y) \in (a, b)$ because:
 - $y \in U_q \subset \overline{U}_q$ which, by the previous claim, implies $f(y) \leq q < b$.
 - $y \notin \overline{U}_p$, hence $y \notin U_p$ which, by the previous claim, implies $f(y) \geq p > a$.

\square

6. More exercises

EXERCISE 5.4. Let \mathcal{A} be the following collection of subsets of \mathbb{R} :

$$\mathcal{A} = \{(n, n + 2) : n \in \mathbb{Z}\}.$$

Which of the following collections refine \mathcal{A} ?

$$\mathcal{B} = \{(x, x + 1) : x \in \mathbb{R}\},$$

$$\mathcal{C} = \{(n, n + \frac{3}{2}) : n \in \mathbb{Z}\},$$

$$\mathcal{C} = \{(x, x + \frac{3}{2}) : x \in \mathbb{R}\}.$$

EXERCISE 5.5. Which of the collections from the previous exercise is locally finite?

EXERCISE 5.6. Show that if a family $\{p_i : i \in I\}$ of non-zero polynomial functions $p_i : \mathbb{R} \rightarrow \mathbb{R}$ is locally finite, then it must be finite.

EXERCISE 5.7. Let $\mathcal{P} \subset \mathcal{C}(\mathbb{R})$ be the space of all polynomial functions on \mathbb{R} . Is \mathcal{P} normal?

EXERCISE 5.8. Show that the space $\mathcal{C}^1(\mathbb{R}) \subset \mathcal{C}(\mathbb{R})$ of functions of class \mathcal{C}^1 is normal. What do you conclude from this?

EXERCISE 5.9. Do the same for the space $\mathcal{C}^\infty(\mathbb{R})$ of smooth (i.e. infinitely differentiable) functions on \mathbb{R} .

EXERCISE 5.10. Now do the same for $\mathcal{C}^\infty(\mathbb{R}^n)$.

It is very tempting now to talk about smooth manifolds. These are manifolds on which we can talk about smoothness. More precisely, a smooth manifold is a topological manifold X together with a specified family of coordinate charts $\{\chi_i : U_i \rightarrow \mathbb{R}^n\}$, such that $\{U_i\}$ is an open cover of X , $c_{i,j} := \chi_i \circ \chi_j^{-1}$ is a smooth function. Here, $c_{i,j}$ plays the role of the “change of coordinates” since

$$\chi_i(x) = c_{i,j}(\chi_j(x)).$$

Also, $c_{i,j}$ is a function defined on an open in \mathbb{R}^n (namely $\chi_j(U_i \cap U_j)$) with values in \mathbb{R}^n ; hence it makes sense to talk about its smoothness. Given such a smooth manifold, a function $f : X \rightarrow \mathbb{R}$ is called smooth if its representation in each chart, i.e. each $f \circ \chi_i^{-1} : \mathbb{R}^n \rightarrow \mathbb{R}$ is smooth. Denote by $\mathcal{C}^\infty(X)$ the space of smooth functions on X ; of course, $\mathcal{C}^\infty(X) \subset \mathcal{C}(X)$. Once you get used to all these definitions, the following should not be too difficult now:

EXERCISE 5.11. Show that, for any smooth manifold X , $\mathcal{C}^\infty(X)$ is normal. Deduce that any open cover admits a smooth partition of unity subordinated to it.

In this context, a map $f : X \rightarrow \mathbb{R}^N$ is called smooth if all its components are smooth. Adapting the proof of Theorem 4.30 and using Exercise 5.10 above, one can now try a more difficult exercise:

EXERCISE 5.12. Show that, for any smooth compact manifold X , there exists a smooth embedding $f : X \rightarrow \mathbb{R}^N$, for N large enough.

CHAPTER 6

Metric properties versus topological ones

1. **Completeness and the Baire property**
2. **Boundedness and totally boundedness**
3. **Compactness**
4. **Paracompactness**
5. **More exercises**

1. Completeness and the Baire property

Probably the most important metric property is that of completeness which we now recall.

DEFINITION 6.1. *Given a metric space (X, d) and a sequence $(x_n)_{n \geq 1}$ in X , we say that $(x_n)_{n \geq 1}$ is a Cauchy sequence if*

$$\lim_{n, m \rightarrow \infty} d(x_n, x_m) = 0,$$

i.e., for each $\epsilon > 0$, there exists an integer n_ϵ such that

$$d(x_n, x_m) < \epsilon$$

for all $n, m \geq n_\epsilon$. One says that (X, d) is complete if any Cauchy sequence is convergent.

Very simple examples (see e.g Exercise 1.33 from the first chapter) show that completeness is not a topological property. However, it does have topological consequences. The first one is a relative topological property for complete spaces.

PROPOSITION 6.2. *If (X, d) is a complete metric space then $A \subset X$ is complete (with respect to the restriction of d to A) if and only if A is closed in X .*

PROOF. Assume first that A is complete and show that $\bar{A} = A$. Let $x \in \bar{A}$. Then we find a sequence (a_n) in A converging (in (X, d)) to x . In particular, (a_n) is Cauchy. But the completeness of A implies that the sequence is convergent (in $A!$) to some $a \in A$. Hence $x = a \in A$. This proves that A is closed. For the converse, assume A is closed and let (a_n) be a Cauchy sequence in A . Of course, the sequence is Cauchy also in X . Since X is complete, it will be convergent to some $x \in X$. Since A is closed, $x \in A$, i.e. (a_n) is convergent in A . \square

The next topological property that complete metric spaces automatically have is:

PROPOSITION 6.3. *Any complete metric space (X, d) has the Baire property, i.e. for any countable family $\{U_n\}_{n \geq 1}$ consisting of open sets $U_n \subset X$, if U_n is dense in X for all n , then $\bigcap_n U_n$ is dense in X .*

PROOF. Assume now that $\{U_n\}_{n \geq 1}$ consists of open dense subsets of X . We show that any $x \in X$ is in the closure of $\bigcap_n U_n$. Let U be an open containing x ; we have to show that U intersects $\bigcap_n U_n$. First, since U_1 is dense in X , $U \cap U_1 \neq \emptyset$; choosing x_1 in this intersection, we find $r_1 > 0$ such that $B[x_1, r_1] \subset U \cap U_1$. We may assume $r_1 < 1$. Next, since U_2 is dense in X , $B(x_1, r_1) \cap U_2 \neq \emptyset$; choosing x_2 in this intersection, we find $r_2 > 0$ such that $B[x_2, r_2] \subset B(x_1, r_1) \cap U_2$. We may assume $r_2 < 1/2$. Similarly, we find x_3 and $r_3 < 1/3$ such that $B[x_3, r_3] \subset B(x_2, r_2) \cap U_3$ and we continue inductively. Then the resulting sequence (x_n) is Cauchy because $d(x_n, x_m) < r_n$ for $n \leq m$. This implies that (x_n) is convergent to some $y \in X$ and $d(x_n, y) \leq r_n$ for all n . Hence $y \in B[x_n, r_n] \subset U_n$, i.e. $y \in \bigcap_n U_n$. Also, since $B[x_1, r_1] \subset U$, $y \in U$. Hence $U \cap (\bigcap_n U_n) \neq \emptyset$, as we wanted. \square

2. Boundedness and totally boundedness

Another notion that strongly depends on a metric is the notion of boundedness.

DEFINITION 6.4. *Given a metric space (X, d) , we say that $A \subset X$ is*

1. *bounded in (X, d) (or with respect to d) if there exists $x \in X$ and $R > 0$ such that $A \subset B(x, R)$.*
2. *totally bounded in (X, d) if, for any $\epsilon > 0$, there exist a finite number of balls in X of radius ϵ covering A .*

When $A = X$, we say that (X, d) is bounded, or totally bounded, respectively.

You should convince yourself that, when $X = \mathbb{R}^n$ and d is the Euclidean metric, total boundedness with respect to d is equivalent to the usual notion of boundedness.

A few remarks are in order here. First of all, these properties are not really relative properties (i.e. they did not depend on the way that A sits inside X), but properties of the metric space (A, d_A) itself, where d_A is the induced metric on A .

EXERCISE 6.1. Given a metric space (X, d) and $A \subset X$, A is bounded in (X, d) if and only if (A, d_A) is bounded. Similarly for totally bounded.

Another remark is that the property of “totally bounded” is an improvement of that of “bounded”. The following exercise shows that, by a simple trick, a metric d can always be made into a bounded metric \hat{d} without changing the induced topology; although the notion of boundedness is changed, totally boundedness with respect to d and \hat{d} is the same.

EXERCISE 6.2. As in Exercise 1.34, for a metric space (X, d) we define $\hat{d}: X \times X \rightarrow \mathbb{R}$ by

$$\hat{d}(x, y) = \min\{d(x, y), 1\}.$$

We already know that \hat{d} is a metric inducing the same topology on X as d , and that (X, \hat{d}) is complete if and only if (X, d) is. Also, it is clear that (X, \hat{d}) is always bounded. Show now that (X, \hat{d}) is totally bounded if and only if (X, d) is.

Finally, here is a lemma that we will use later on:

LEMMA 6.5. *Given a metric space (X, d) and $A \subset X$, then A is totally bounded if and only if \overline{A} is.*

PROOF. Let $\epsilon > 0$. Choose x_1, \dots, x_k such that A is covered by the balls $B(x_i, \epsilon/2)$. Then \overline{A} will be covered by the balls $B(x_i, \epsilon)$. Indeed, if $y \in \overline{A}$, we find $x \in A$ such that $d(x, y) < \epsilon/2$; also, we find x_i such that $x \in B(x_i, \epsilon/2)$; from the triangle inequality, $y \in B(x_i, \epsilon)$. \square

3. Compactness

The main criteria to recognize when a subspace $A \subset \mathbb{R}^n$ is compact is by checking whether it is closed and bounded in \mathbb{R}^n . For general metric spaces:

THEOREM 6.6. *A subset A of a complete metric space (X, d) is compact if and only if it is closed (in X) and totally bounded (with respect to d).*

This theorem will actually be an immediate consequence of another theorem, which also clarifies the relationship between compactness and sequential compactness for metric spaces.

THEOREM 6.7. *For a metric space (X, d) , the following are equivalent:*

1. X is compact.
2. X is sequentially compact.
3. X is complete and totally bounded.

PROOF. We first prove Theorem 6.7. The implication $1 \implies 2$ is Corollary 4.33. For $2 \implies 3$, assume that X is sequentially compact. We first prove that X is complete. Let $(x_n)_{n \geq 1}$ be a Cauchy sequence. By hypothesis, we find a convergent subsequence $(x_{n_k})_{k \geq 1}$. Let x be its limit. We prove that the entire sequence (x_n) converges to x . Let $\epsilon > 0$. We look for an integer N_ϵ such that $d(x_n, x) < \epsilon$ for all $n > N_\epsilon$. Since (x_n) is Cauchy we find N'_ϵ such that

$$d(x_n, x_m) < \epsilon/2$$

for all $n, m \geq N'_\epsilon$. Since $(x_{n_k})_{k \geq 1}$ converges to x , we find k_ϵ such that

$$d(x_{n_k}, x) < \epsilon/2$$

for all $k \geq k_\epsilon$. Choose $N_\epsilon = \max\{N'_\epsilon, n_{k_\epsilon}\}$. Then, for $n > N_\epsilon$, choosing k such that $n_k > n$ (such a k exists since $n_1 < n_2 < \dots$ is a sequence that tends to ∞), we must have $k > k_\epsilon$ and $n_k > N'_\epsilon$, hence

$$d(x_n, x_{n_k}) < \epsilon/2, \quad d(x_{n_k}, x) < \epsilon/2.$$

Using the triangle inequality, we obtain $d(x_n, x) < \epsilon$, and this holds for all $n \geq N_\epsilon$. This proves that (x_n) converges to x . We now prove that X is totally bounded. Assume it is not. Then we find $r > 0$ such that X cannot be covered by a finite number of balls of radius r . Construct a sequence $(x_n)_{n \geq 1}$ as follows. Start with any $x_1 \in X$. Since $X \neq B(x_1, r)$, we find $x_2 \in X - B(x_1, r)$. Since $X \neq B(x_1, r) \cup B(x_2, r)$, we find $x_3 \in X - B(x_1, r) \cup B(x_2, r)$. Continuing like this we find a sequence with $x_n \notin B(x_m, r)$ for $n > m$. Hence $d(x_n, x_m) > r$ for all $n \neq m$. But by hypothesis, (x_n) has a subsequence $(x_{n_k})_{k \geq 1}$ which converges to some $x \in X$. But then we find N such that $d(x_{n_k}, x) < r/2$ for all $k \geq N$, hence

$$d(x_{n_k}, x_{n_l}) \leq d(x_{n_k}, x) + d(x, x_{n_l}) < r$$

for all $k, l \geq N$, and this contradicts the condition " $d(x_n, x_m) > r$ for all $n \neq m$ ".

$3 \implies 1$: Assume that (X, d) is complete and totally bounded. The last condition ensures that for each integer $n \geq 0$, there is a finite set $F_n \subset X$ such that

$$X = \bigcup_{x \in F_n} B(x, \frac{1}{2^n}).$$

Let $\mathcal{U} = \{U_i : i \in I\}$ be an open cover of X , and we want to prove that we can extract a finite subcover of \mathcal{U} . Assume this is not possible. We construct a sequence $(x_n)_{n \geq 1}$ inductively as follows. Since $\cup_{x \in F_1} B(x, \frac{1}{2}) = \cup_i U_i$, and the first union is a finite union (F_1 is finite), we find $x_1 \in F_1$ such that $B(x_1, \frac{1}{2})$ cannot be covered by a finite number of opens from \mathcal{U} . Now, since

$$B(x_1, \frac{1}{2}) = \bigcup_{x \in F_2} (B(x_1, \frac{1}{2}) \cap B(x, \frac{1}{4}))$$

we find $x_2 \in F_2$ such that

$$B(x_1, \frac{1}{2}) \cap B(x_2, \frac{1}{4}) \neq \emptyset$$

and $B(x_2, \frac{1}{4})$ cannot be covered by a finite numbers of opens from \mathcal{U} . Continuing this, at step n we find $x_n \in F_n$ such that

$$B(x_{n-1}, \frac{1}{2^{n-1}}) \cap B(x_n, \frac{1}{2^n}) \neq \emptyset$$

and $B(x_n, \frac{1}{2^n})$ cannot be covered by a finite number of opens from \mathcal{U} . Note that, choosing an element y in the (non-empty) intersection above, the triangle inequality implies that

$$d(x_{n-1}, x_n) < \frac{1}{2^{n-1}} + \frac{1}{2^n} = \frac{3}{2^n},$$

from which we deduce that $(x_n)_{n \geq 1}$ is a Cauchy sequence (why?). By hypothesis, it will converge to an element $x \in X$. Choose $U \in \mathcal{U}$ such that $x \in U$. Since U is open, we find $\epsilon > 0$ such that $B(x, \epsilon) \subset U$. Since $x_n \rightarrow x$, we find n_ϵ such that $d(x_n, x) < \epsilon/2$ for all $n > n_\epsilon$. Using the triangle inequality, we deduce that $B(x_n, \epsilon/2) \subset U$ for all $n \geq n_\epsilon$. Choosing n so that also $1/2^n < \epsilon/2$, we deduce that $B(x_n, 1/2^n) \subset U$, which contradicts the fact that $B(x_n, \frac{1}{2^n})$ cannot be covered by of finite number of opens from \mathcal{U} .

This ends the proof of Theorem 6.7. For Theorem 6.6, one uses the equivalence between 1 and 3 above, applied to the metric space (A, d_A) , and Proposition 6.2. \square

We now derive some more properties of compactness in the metric case. In what follows, given $F \subset X$, we say that F is relatively compact in X if the closure \overline{F} in X is compact.

COROLLARY 6.8. *For a subset F of a complete metric space (X, d) , the following are equivalent*

1. F is relatively compact in X .
2. any sequence in F admits a convergent subsequence (with some limit in X).
3. F is totally bounded.

PROOF. We apply Theorem 6.7 to \overline{F} . We know that 3 is equivalent to the same condition for \overline{F} (Lemma 6.5). We prove the same for 2; the non-obvious part is to show that \overline{F} satisfies 2 if F does. So, let (y_n) be a sequence in \overline{F} . For each n we find $x_n \in F$ such that $d(x_n, y_n) < 1/n$. After eventually passing to a subsequence, we may assume that (x_n) is convergent to some $x \in X$ and $d(x_n, y_n) \rightarrow 0$ as $n \rightarrow \infty$. But this implies that (y_n) itself must converge to x . \square

COROLLARY 6.9. *Any compact metric space (X, d) is separable, i.e. there exists $A \subset X$ which is at most countable and which is dense in X .*

PROOF. For each n choose a finite set A_n such that X is covered by $B(a, \frac{1}{n})$ with $a \in A_n$. Then $A := \cup A_n$ is dense in X : for $x \in X$ and ϵ we have to show that $B(x, \epsilon) \cap A \neq \emptyset$; but we find n with $\frac{1}{n} < \epsilon$ and $a \in A_n$ such that $x \in B(a, \frac{1}{n})$; then $a \in B(x, \epsilon) \cap A$. \square

PROPOSITION 6.10. *(the Lebesgue lemma) If (X, d) is a compact metric space then, for any open cover \mathcal{U} of X , there exists $\delta > 0$ such that*

$$A \subset X, \text{diam}(A) < \delta \implies \exists U \in \mathcal{U} \text{ such that } A \subset U.$$

(δ is called a Lebesgue number for the cover \mathcal{U}).

PROOF. It suffices to show that there exists δ such that each ball $B(x, \delta)$ is contained in some $U \in \mathcal{U}$. If no such δ exists, we find $\delta_n \rightarrow 0$ such that $B(x_n, \delta_n)$ is not inside any $U \in \mathcal{U}$. Using (sequential) compactness we may assume that (x_n) is convergent, with some limit $x \in X$ (if not, pass to a convergent subsequence). Let $U \in \mathcal{U}$ with $x \in U$ and let $r > 0$ with $B(x, r) \subset U$. Since $\delta_n \rightarrow 0$, $x_n \rightarrow x$, we find n s.t. $\delta_n < r/2$, $d(x_n, x) < r/2$. From the triangle inequality, $B(x_n, \delta_n) \subset B(x, r) (\subset U)$ which contradicts the choice of x_n and δ_n . \square

4. Paracompactness

Finally, we show that:

THEOREM 6.11. *Any metric space is paracompact.*

PROOF. Start with an arbitrary open cover $\mathcal{U} = \{U_i : i \in I\}$ of X . We consider an order relation “ \leq ” on I , which makes I into a well-ordered set (i.e. so that any subset of I has a smallest element). We will construct a locally finite refinement of type $\mathcal{V} = \cup_{n \in \mathbb{N}} \mathcal{V}_n$ where, for each n , the family $\mathcal{V}(n)$ will have one member for each $i \in I$; i.e. it is of type:

$$\mathcal{V}(n) = \{V_i(n) : i \in I\}.$$

We set $X(n) = \cup_i V_i(n)$. The definition of $\mathcal{V}(n)$ is by induction on n . For $n = 1$:

$$V_i(1) := \bigcup_{a \in U_i - (\cup_{j < i} U_j) \text{ with } B(a, \frac{3}{2}) \subset U_i} B(a, \frac{1}{2}).$$

Assuming that $\mathcal{V}(1), \dots, \mathcal{V}(n-1)$ have been constructed, we define, for each $i \in I$:

$$V_i(n) = \bigcup_{a \in U_i - (\cup_{j < i} U_j) \text{ with } B(a, \frac{3}{2^n}) \subset U_i, a \notin X(1) \cup \dots \cup X(n-1)} B(a, \frac{1}{2^n}).$$

It is clear that \mathcal{V} is a refinement of \mathcal{U} . Next, we claim that $X = \cup_n X(n)$ (i.e. \mathcal{V} is a cover): for $x \in X$, choose the smallest i such that $x \in U_i$ and choose n such that $B(x, 3/2^n) \subset U_i$; then either $x \in X(1) \cup \dots \cup X(n-1)$ and we are done, or x can serve as an index in the definition of $V_i(n)$, hence $x \in X(n)$. Before showing local finiteness, we remark that, for each n :

$$(4.1) \quad d(V_i(n), V_j(n)) \geq \frac{1}{2^n} \quad \forall i \neq j.$$

To see this, assume that $i < j$ and let $x \in V_i(n), y \in V_j(n)$. Then $x \in B(a, \frac{1}{2^n})$ for some $a \in X$ with $B(a, \frac{3}{2^n}) \subset U_i$ and $y \in B(b, \frac{1}{2^n})$ for some $b \in X$ with $b \notin U_i$. These imply that $b \notin B(a, \frac{3}{2^n})$, i.e. $d(a, b) \geq \frac{3}{2^n}$. From the triangle inequality:

$$d(x, y) \geq d(a, b) - d(a, x) - d(b, y) > \frac{3}{2^n} - \frac{1}{2^n} - \frac{1}{2^n} = \frac{1}{2^n}.$$

We now show local finiteness. Let $x \in X$. Fix $n_0 \geq 1$ integer, $i_0 \in I$ with $x \in V_{i_0}(n_0)$. Also, choose $n_1 \geq 1$ integer with

$$(4.2) \quad B(x, \frac{1}{2^{n_1}}) \subset V_{i_0}(n_0).$$

We claim that

$$V := B(x, r) \quad \text{where } r = \frac{1}{2^{n_0+n_1}}$$

intersects only a finite number of members of \mathcal{V} . This follows from the following two remarks

1. For $n < n_0 + n_1$, V intersects at most one member of the family $\mathcal{V}(n)$.
2. For $n \geq n_0 + n_1$, V intersects no member of the family $\mathcal{V}(n)$.

Part 1 follows from (4.1): if V intersects both $V_i(n)$ and $V_j(n)$ with $i \neq j$, we would find $a, b \in V$ with $d(a, b) \geq \frac{1}{2^n}$ but $d(a, b) \leq d(a, x) + d(x, b) < 2r \leq \frac{1}{2^n}$ for all $a, b \in V$.

For part 2, assume that $n \geq n_0 + n_1$. Assume that $V \cap V_i(n) = \emptyset$ for some $i \in I$. From the definition of $V_i(n)$, we then find $B(a, \frac{1}{2^n}) \cap V \neq \emptyset$ for some $a \in U_i - (\cup_{j < i} U_j)$, with $B(a, \frac{3}{2^n}) \subset U_i$, $a \notin X(1) \cup \dots \cup X(n-1)$. Since $n > n_0$, we have $a \notin X(n_0)$, hence $a \notin V_{i_0}(n_0)$. From the choice of n_1 (see (4.2) above), $a \notin B(x, \frac{1}{2^{n_1}})$, hence $d(a, x) \geq \frac{1}{2^{n_1}}$. But, by the triangle inequality again, this implies that $B(a, \frac{1}{2^n}) \cap B(x, r) = \emptyset$. I.e., for any a which contributes to the definition of $V_i(n)$, its contribution $B(a, \frac{1}{2^n})$ does not intersect V . Hence $V \cap V_i(n) = \emptyset$. \square

5. More exercises

EXERCISE 6.3. Let (X, d) be a metric space. Show that any sequence $(x_n)_{n \geq 1}$ in X with the property that

$$d(x_{n+1}, x_n) \leq \frac{d(x_n, x_{n-1})}{2}$$

for all n , is Cauchy.

EXERCISE 6.4. Let (X, d) be a complete metric space and let $f : X \rightarrow X$ be a map with the property that there exists $\lambda \in (0, 1)$ such that

$$d(f(x), f(y)) \leq \lambda d(x, y)$$

for all $x, y \in X$. Show that f has a unique fixed point (i.e. $a \in X$ with $f(a) = a$).

(Hint: the difficult part is the existence. Start with any x_0 and consider $x_{n+1} = f(x_n)$).

EXERCISE 6.5. We say that a topological space X is separable if there exists $A \subset X$ countable and dense in X .

1. Show that if X is 2nd countable, then it is separable.
2. Show that a metric space is 2nd countable if and only if it is separable.
3. Deduce that $(\mathbb{R}, \mathcal{T}_l)$ is not metrizable (see exercise 2.19).

CHAPTER 7

Metrizability theorems

1. The Urysohn metrization theorem
2. The Smirnov metrization theorem
3. Consequences: the compact case, the locally compact case, manifolds
4. More exercises

1. The Urysohn metrization theorem

In following is known as the Urysohn metrization theorem.

THEOREM 7.1. *Any topological space which is normal and second countable is metrizable.*

The rest of this section is devoted to the proof of this theorem.

Claim 1: \exists a countable family $(f_n)_{n \geq 0}$ of continuous functions $f_n : X \rightarrow [0, 1]$ satisfying:

$$(1.1) \quad (\forall U - \text{open}, x \in U), (\exists N \in \mathbb{Z}) \text{ such that: } (f_N(x) = 1, f_N = 0 \text{ outside } U).$$

PROOF. Let $\mathcal{B} = \{B_1, B_2, \dots\}$ be a countable basis for the topology \mathcal{T} . Consider

$$I = \{(n, m) : \overline{B}_n \subset B_m\} \subset \mathbb{N} \times \mathbb{N}.$$

This is countable (subset of countable is countable), hence we can enumerate it as $(n_0, m_0), (n_1, m_1), \dots$. For each i , using Urysohn's lemma, we find a continuous function $f_i : X \rightarrow [0, 1]$ such that $f_i|_{\overline{B}_{n_i}} = 1, f_i|_{X - B_{m_i}} = 0$. Then $(f_i)_{i \geq 0}$ has the desired properties: for $U \in \mathcal{T}$ and $x \in U$, we can choose m such that $x \in B_m \subset U$. By Lemma 5.3, we find V -open containing x such that $x \in V \subset \overline{V} \subset B_m$. Since \mathcal{B} is a basis, we find n such that $x \in B_n \subset V$. Then $\overline{B}_n \subset \overline{V} \subset B_m$, hence $(n, m) \in I$. Writing $(n, m) = (n_N, m_N)$ with $N \in \mathbb{N}$, since $x \in B_n$ we have $f_N(x) = 1$, and since $B_m \subset U$, we have $f_N = 0$ outside B_m hence also outside U . \square

Claim 2: The following is a metric on X inducing the topology of X :

$$d : X \times X \rightarrow \mathbb{R}, \quad d(x, y) = \sup \left\{ \frac{|f_n(x) - f_n(y)|}{n} : n \geq 1 \text{ integer} \right\}.$$

PROOF. Note that $d(x, y)$ is finite since $0 \leq f_n \leq 1$. For the triangle inequality, we use:

$$\frac{|f_n(x) - f_n(y)|}{n} \leq \frac{|f_n(x) - f_n(z)|}{n} + \frac{|f_n(z) - f_n(y)|}{n} \leq d(x, z) + d(z, y)$$

for all n . To see that $d(x, y) \neq 0$ whenever $x \neq y$, choose $U \in \mathcal{T}$ containing x and not containing y , choose N as in (1.1) and remark that $|f_N(x) - f_N(y)| = 1$ hence $d(x, y) \geq 1/N > 0$.

Next, we show that $\mathcal{T} \subset \mathcal{T}_d$. Let $U \in \mathcal{T}$ and we have to show that:

$$\forall x \in U, \exists \epsilon > 0 : B_d(x, \epsilon) \subset U.$$

Let $x \in U$ and choose N as in (1.1). Then $\epsilon := \frac{1}{N}$ does the job. Indeed, if $y \in B_d(x, \epsilon)$, then

$$\frac{|1 - f_N(y)|}{N} = \frac{|f_N(x) - f_N(y)|}{N} \leq d(x, y) < \frac{1}{N},$$

hence $f_N(y) \neq 0$ and this can only happen if $y \in U$.

Finally, we show that $\mathcal{T}_d \subset \mathcal{T}$. It suffices to prove that, for each ball $B(x, \epsilon)$, there exists $U = U_{x, \epsilon} \in \mathcal{T}$ such that $x \in U \subset B(x, \epsilon)$. This will imply that $B(x, \epsilon)$ is open in X : indeed, for any $y \in B(x, \epsilon)$ we can choose $r > 0$ such that $B(y, r) \subset B(x, \epsilon)$ (e.g. take $r = \epsilon - d(x, y)$ and use the triangle inequality), and then $U_{y, r}$ will be an open in X contained in $B(x, \epsilon)$.

So, let us fix $x \in X, \epsilon > 0$ and look for $U \in \mathcal{T}$ with $x \in U \subset B(x, \epsilon)$. Choose $n > 2/\epsilon$ and set

$$U := \bigcap_{n=1}^{n_0} \left\{ y \in X : \frac{|f_n(y) - f_n(x)|}{n} < \epsilon \right\}.$$

Since this is a finite intersection and each f_n is continuous, we have $U \in \mathcal{T}$. Clearly, $x \in U$. Note also that, from the choice of n_0 and the fact that $0 \leq |f_n| \leq 1$,

$$\frac{|f_n(x) - f_n(y)|}{n} \leq \frac{2}{n_0} < \epsilon \quad \forall n \geq n_0.$$

We deduce that $d(x, y) < \epsilon$ for all $y \in U$, i.e. $U \subset B(x, \epsilon)$. \square

2. The Smirnov Metrization Theorem

In following is known as the Smirnov Metrization Theorem.

THEOREM 7.2. *A space X is metrizable iff it is Hausdorff, paracompact and locally metrizable.*

Theorem 6.11 takes care of the direct implication. Here we prove the converse. The proof is very similar to the proof of the Urysohn metrization theorem.

Claim 1: There exists a basis \mathcal{B} for the topology of X , of type $\mathcal{B} = \cup_{n \in \mathbb{N}^*} \mathcal{B}_n$, where each \mathcal{B}_n is a locally finite family. Moreover, for each $B \in \mathcal{B}$, there is a continuous function

$$f_B : X \rightarrow [0, 1] \quad \text{such that} \quad B = \{x \in X : f_B(x) \neq 0\}.$$

PROOF. From the hypothesis it follows that there is a cover $\mathcal{U} = \{U_i : i \in I\}$ of X by opens in X , on which the topology is induced by a metric d_i ; we may assume that $d_i \leq 1$ (cf. e.g. Exercise 1.34). For each $i \in I$, we denote by $B_i(x, r)$ the balls induced by d_i . They are open subsets of U_i , hence also open in X . By the shrinking lemma (Lemma 5.17), we can find another locally finite cover $\{V_i : i \in I\}$ with $\bar{V}_i \subset U_i$. For each integer n , we consider the open cover of X

$$\{B_i(x, \frac{1}{n}) \cap V_i : i \in I, x \in U_i\}.$$

Let \mathcal{B}_n be a locally finite refinement of it and $\mathcal{B} = \cup_n \mathcal{B}_n$. For each $B \in \mathcal{B}$, we find i such that $B \subset V_i$ and then $f_B(x) := d_i(x, U_i - B)$ is a well-defined continuous function on U_i with which is zero outside B ; since $\bar{B} \subset \bar{V}_i \subset U_i$ (where all the closures are in X), extending f_B by zero outside U_i , it will give us a function with the desired properties.

Finally, we show that \mathcal{B} is a basis. Consider $U \subset X$ open, $x \in U$; we show that $x \in B \subset U$ for some $B \in \mathcal{B}$. Since \mathcal{U} is locally finite, there is only a finite set of indices i with $x \in U_i$; call it F_x . For each $i \in F_x$, $U \cap U_i$ is open in (U_i, d_i) hence we find ϵ_i such that $B_i(x, \epsilon_i) \subset U \cap U_i$. Choose m with $2/m < \epsilon_i$ for all $i \in F_x$. Choose $B \in \mathcal{B}_m$ such that $x \in B$; due to the definition of \mathcal{B}_m , we have $B \subset B_i(y, 1/m)$ for some $i \in I$, $y \in U_i$. In particular, $x \in U_i$, hence $i \in F_x$. From the choice of m , we have $B_i(y, 1/m) \subset B_i(x, \epsilon_i)$; from the choice of ϵ_i , these are inside U . \square

Claim 2: The following is a metric on X inducing the topology \mathcal{T} of X .

$$d : X \times X \rightarrow \mathbb{R}, \quad d(x, y) = \sup\{\frac{1}{n}|f_B(x) - f_B(y)| : n \geq 1 \text{ integer}, B \in \mathcal{B}_n\}.$$

PROOF. By the same argument as in the Urysohn metrization theorem, d is a metric. Next, we show that $\mathcal{T} \subset \mathcal{T}_d$. Let $U \subset X$ open, $x \in U$. We have to find $r > 0$ such that $B_d(x, r) \subset U$. Since \mathcal{B} is a basis, we find $B \in \mathcal{B}_n$ for some n , with $x \in B \subset U$. We claim that $r = \frac{1}{n}|f_B(x)|$ does the job. Indeed, if $y \in B_d(x, r)$, we have $\frac{1}{n}|f_B(y) - f_B(x)| < \frac{1}{n}|f_B(x)|$, hence $f_B(y) \neq 0$, hence $y \in B$, hence $y \in U$.

Finally, we show that $\mathcal{T}_d \subset \mathcal{T}$. It suffices to show that, for any $x \in X$, $r > 0$, there exists $U \in \mathcal{T}$ such that $x \in U \subset B_d(x, r)$. Let $n_0 > 2/r$ be an integer. Since each \mathcal{B}_n is locally finite, we find a neighborhood V of x which intersects only a finite number of B s with $B \in \mathcal{B}_n$, $n \leq n_0$. Call these members B_1, \dots, B_k . Choose $U \subset V$ such that

$$(2.1) \quad |f_{B_i}(y) - f_{B_i}(x)| < r \quad \forall y \in U, \forall i \in \{1, \dots, k\}.$$

We claim that $U \subset B_d(x, r)$. That means that, for any $y \in U$, we have $\frac{1}{n}|f_B(y) - f_B(x)| < r$ for all $n \geq 1$ and $B \in \mathcal{B}_n$. If $n \geq n_0$ this is automatically satisfied since $|f_B| \leq 1$ and $2/n \leq 2/n_0 < r$. Assume now that $n \leq n_0$. If B is not one of the B_1, \dots, B_k , then $U \cap B = \emptyset$ hence $f_B(y) = f_B(x) = 0$ and we are done. Finally, if $B = B_i$ for some i , then the desired inequality follows from (2.1). \square

3. Consequences: the compact case, the locally compact case, manifolds

Here are some consequences of the metrization theorems from the previous sections. First of all, since topological manifolds are paracompact (see e.g. 5.20), the Smirnov metrization theorem immediately implies

THEOREM 7.3. *Any topological manifold is metrizable.*

This theorem follows also from the Urysohn metrization theorem (but note that the proof base on Smirnov's result is somehow more satisfactory: it uses paracompactness to pass from the local information to the global one; in particular, the Urysohn lemma is not used!). The Urysohn metrization theorem has however two more interesting consequences. First, for the compact case, we obtain:

THEOREM 7.4. *If X is a compact Hausdorff space, then the following are equivalent*

1. X is metrizable.
2. X is second countable.

Using the one-point compactification, for locally compact spaces we will obtain the following (which provides another proof to Theorem 7.3).

THEOREM 7.5. *Any locally compact Hausdorff and 2nd countable space is metrizable.*

In what follows, we will provide the missing proofs.

PROOF. (of Theorem 7.4) The reverse implication follows from the Urysohn metrization theorem since compact spaces are normal (Corollary 4.20). We now prove $1 \implies 2$. Let d be a metric inducing the topology of X . Since X is totally bounded (cf. Theorem 6.7), for each n we find a finite set F_n such that

$$X = \bigcup_{x \in F_n} B(x, \frac{1}{n}).$$

The set $A = \cup_n F_n$ is a countable union of finite sets, hence it is countable. We deduce that

$$\mathcal{B} = \{B(a, \frac{1}{n}) : a \in A, n \geq 1 \text{ integer}\}$$

is a countable family of open sets of X . We claim it is a basis for the topology of X . Let U be an arbitrary open and $x \in U$. We have to prove that there exists $B \in \mathcal{B}$ such that $x \in B \subset U$. Since $x \in U$, we find an integer n such that $B(x, \frac{1}{n}) \subset U$. Using the defining property for F_{2n} , we see that there exists $a \in A$ such that $x \in B(a, \frac{1}{2n})$. Using the triangle inequality, we deduce that for each $y \in B(a, \frac{1}{2n})$,

$$d(x, y) \leq d(x, a) + d(a, y) < \frac{1}{2n} + \frac{1}{2n} = \frac{1}{n},$$

hence $y \in B(x, \frac{1}{n}) \subset U$. In conclusion, $B = B(a, \frac{1}{2n}) \in \mathcal{B}$ satisfies $x \in B \subset U$. □

PROOF. (of Theorem 7.5) We apply the Theorem 7.4 to the one-point compactification (see Theorem 4.39) to deduce that X^+ is metrizable. Since X is a subspace of X^+ , it is itself metrizable. □

CHAPTER 8

Spaces of functions

1. **The algebra $\mathcal{C}(X)$ of continuous functions**
2. **Approximations in $\mathcal{C}(X)$: the Stone-Weierstrass theorem**
3. **Recovering X from $\mathcal{C}(X)$: the Gelfand Naimark theorem**
4. **General function spaces $\mathcal{C}(X, Y)$**
 - Pointwise convergence, uniform convergence, compact convergence
 - Equicontinuity
 - Boundedness
 - The case when X is a compact metric spaces
 - The Arzela-Ascoli theorem
 - The compact-open topology
5. **More exercises**

1. The algebra $\mathcal{C}(X)$ of continuous functions

We start this chapter with a discussion of continuous functions from a Hausdorff compact space to the real or complex numbers. It makes no difference whether we work over \mathbb{R} or \mathbb{C} , so let's just use the notation \mathbb{K} for one of these base fields and we call it the field of scalars. For each $z \in \mathbb{K}$, we can talk about $|z| \in \mathbb{R}$ —the absolute value of z in the real case, or the norm of the complex number z in the complex case.

For a compact Hausdorff space X , we consider the set of scalar-valued functions on X :

$$\mathcal{C}(X) := \{f : X \rightarrow \mathbb{K} : f \text{ is continuous}\}.$$

When we want to make a distinction between the real and complex case, we will use the more precise notations $\mathcal{C}(X, \mathbb{R})$ and $\mathcal{C}(X, \mathbb{C})$.

In this section we look closer at the “structure” that is present on $\mathcal{C}(X)$. First, there is a topological one. When X was an interval in \mathbb{R} , this was discussed in Section 9, Chapter 3 (there $n = 1$ in the real case, $n = 2$ in the complex one). As there, there is a metric on $\mathcal{C}(X)$:

$$d_{\text{sup}}(f, g) := \sup\{|f(x) - g(x)| : x \in \mathbb{R}\}.$$

Since f, g are continuous and X is compact, $d_{\text{sup}}(f, g) < \infty$. As in *loc.cit.*, d_{sup} is a metric and the induced topology is called the uniform topology on $\mathcal{C}(X)$. And, still as in *loc.cit.*:

THEOREM 8.1. *For any compact Hausdorff space X , $(\mathcal{C}(X), d_{\text{sup}})$ is a complete metric space.*

PROOF. Let (f_n) be a Cauchy sequence in $\mathcal{C}(X)$. The proof of Theorem 3.27 applies word by word to our X instead of the interval I , to obtain a function $f : X \rightarrow \mathbb{R}$ such that $d_{\text{sup}}(f_n, f) \rightarrow 0$ when $n \rightarrow \infty$. Then similarly, the proof of Theorem 3.26 (namely that $\mathcal{C}(I, \mathbb{R}^n)$ is closed in $(\mathcal{F}(I, \mathbb{R}^n), \hat{d}_{\text{sup}})$) applies word by word with I replaced by X to conclude that $f \in \mathcal{C}(X)$. \square

The metric on $\mathcal{C}(X)$ is of a special type: it comes from a norm. Namely, defining

$$\|f\|_{\text{sup}} := \sup\{|f(x)| : x \in X\} \in [0, \infty)$$

for $f \in \mathcal{C}(X)$, we have

$$d_{\text{sup}}(f, g) = \|f - g\|_{\text{sup}}.$$

DEFINITION 8.2. *Let V be a vector space (over our $\mathbb{K} = \mathbb{R}$ or \mathbb{C}). A norm on V is a function*

$$\|\cdot\| : V \rightarrow [0, \infty), \quad v \mapsto \|v\|$$

such that

$$\|v\| = 0 \iff v = 0$$

and is compatible with the vector space structure in the sense that:

$$\|\lambda v\| = |\lambda| \cdot \|v\| \quad \forall \lambda \in \mathbb{K}, v \in V,$$

$$\|v + w\| \leq \|v\| + \|w\| \quad \forall v, w \in V.$$

The metric associated to $\|\cdot\|$ is the metric $d_{\|\cdot\|}$ given by

$$d_{\|\cdot\|}(v, w) := \|v - w\|.$$

A Banach space is a vector space V endowed with a norm $\|\cdot\|$ such that $d_{\|\cdot\|}$ is complete. When $\mathbb{K} = \mathbb{R}$ we talk about real Banach spaces, when $\mathbb{K} = \mathbb{C}$ about complex ones.

With these, we can now reformulate our discussion as follows:

COROLLARY 8.3. *For any compact Hausdorff space X , $(\mathcal{C}(X), \|\cdot\|_{\text{sup}})$ is a Banach space.*

Of course, this already makes reference to some of the algebraic structure on $\mathcal{C}(X)$ - that of vector space. But, of course, there is one more natural operation on continuous functions: the multiplication, defined pointwise:

$$(fg)(x) = f(x)g(x).$$

DEFINITION 8.4. A \mathbb{K} -algebra is a vector space A over \mathbb{K} together with an operation

$$A \times A \rightarrow A, \quad (a, b) \mapsto a \cdot b$$

which is unital in the sense that there exists an element $1 \in A$ such that

$$1 \cdot a = a \cdot 1 = a \quad \forall a \in A,$$

and which is \mathbb{K} -bilinear and associative, i.e., for all $a, a', b, b', c \in A$, $\lambda \in \mathbb{K}$,

$$(a + a') \cdot b = a \cdot b + a' \cdot b, \quad a \cdot (b + b') = a \cdot b + a \cdot b',$$

$$(\lambda a) \cdot b = \lambda(a \cdot b) = a \cdot (\lambda b),$$

$$a \cdot (b \cdot c) = (a \cdot b) \cdot c.$$

We say that A is commutative if $a \cdot b = b \cdot a$ for all $a, b \in A$.

EXAMPLE 8.5. The space of polynomials $\mathbb{K}[X_1, \dots, X_n]$ in n variables (with coefficients in \mathbb{K}) is a commutative algebra.

Hence the algebraic structure of $\mathcal{C}(X)$ is that of an algebra. Of course, the algebraic and the topological structures are compatible. Here is the precise abstract definition.

DEFINITION 8.6. A Banach algebra (over \mathbb{K}) is an algebra A equipped with a norm $\|\cdot\|$ which makes $(A, \|\cdot\|)$ into a Banach space, such that the algebra structure and the norm are compatible, in the sense that,

$$\|a \cdot b\| \leq \|a\| \cdot \|b\| \quad \forall a, b \in A.$$

Hence, with all these terminology, the full structure of $\mathcal{C}(X)$ is summarized in the following:

COROLLARY 8.7. For any compact Hausdorff space, $\mathcal{C}(X)$ is a Banach algebra.

There is a bit more one can say in the case when $\mathbb{K} = \mathbb{C}$: there is also the operation of conjugation, defined again pointwise:

$$\overline{f}(x) := \overline{f(x)}.$$

As before, this comes with an abstract definition:

DEFINITION 8.8. A $*$ -algebra is an algebra A over \mathbb{C} together with an operation

$$(-)^* : A \rightarrow A, \quad a \mapsto a^*,$$

which is an involution, i.e.

$$(a^*)^* = a \quad \forall a \in A,$$

and which satisfies the following compatibility relations with the rest of the structure:

$$(\lambda a)^* = \overline{\lambda} a^* \quad \forall a \in A, \lambda \in \mathbb{C},$$

$$1^* = 1, (a + b)^* = a^* + b^*, (ab)^* = b^* a^* \quad \forall a, b \in A.$$

Finally, a C^* -algebra is a Banach algebra $(A, \|\cdot\|)$ endowed with a $*$ -algebra structure, s.t.

$$\|a^*\| = \|a\|, \quad \|a^* a\| = \|a\|^2 \quad \forall a \in A.$$

Of course, \mathbb{C} with its norm is the simplest example of C^* -algebra. To summarize our discussion in the complex case:

COROLLARY 8.9. For any compact Hausdorff space, $\mathcal{C}(X, \mathbb{C})$ is a C^* -algebra.

2. Approximations in $\mathcal{C}(X)$: the Stone-Weierstrass theorem

The Stone-Weierstrass theorem is concerned with density in the space $\mathcal{C}(X)$ (endowed with the uniform topology); the simplest example is Weierstrass's approximation theorem which says that, when X is a compact interval, the set of polynomial functions is dense in the space of all continuous functions. The general criterion makes use of the algebraic structure on $\mathcal{C}(X)$.

DEFINITION 8.10. *Given an algebra A (over the base field \mathbb{R} or \mathbb{C}), a subalgebra is any vector subspace $B \subset A$, containing the unit 1 and such that*

$$b \cdot b' \in B \quad \forall b, b' \in B.$$

When we want to be more specific about the base field, we talk about real or complex subalgebras.

EXAMPLE 8.11. When $X = [0, 1]$, the set of polynomial functions on $[0, 1]$ is a unital subalgebra of $\mathcal{C}([0, 1])$. Here the base field can be either \mathbb{R} or \mathbb{C} .

DEFINITION 8.12. *Given a topological space X and a subset $\mathcal{A} \subset \mathcal{C}(X)$, we say that \mathcal{A} is point-separating if for any $x, y \in X$, $x \neq y$ there exists $f \in \mathcal{A}$ such that $f(x) \neq f(y)$.*

EXAMPLE 8.13. When $X = [0, 1]$, the subalgebra of polynomial functions is point-separating.

Here is the Stone-Weierstrass theorem in the real case ($\mathbb{K} = \mathbb{R}$).

THEOREM 8.14. *(Stone-Weierstrass) Let X be a compact Hausdorff space. Then any point-separating real subalgebra $\mathcal{A} \subset \mathcal{C}(X, \mathbb{R})$ is dense in $(\mathcal{C}(X, \mathbb{R}), d_{sup})$.*

PROOF. We first show that there exists a sequence $(p_n)_{n \geq 1}$ of real polynomials which, on the interval $[0, 1]$, converges uniformly to the function \sqrt{t} . We construct p_n inductively by

$$p_{n+1}(t) = p_n(t) + \frac{1}{2}(t - p_n(t)^2), \quad p_1 = 0.$$

We first claim that $p_n(t) \leq \sqrt{t}$ for all $t \in [0, 1]$. This follows by induction on n since

$$\sqrt{t} - p_{n+1}(t) = (\sqrt{t} - p_n(t))\left(1 - \frac{\sqrt{t} + p_n(t)}{2}\right).$$

and $p_n(t) \leq \sqrt{t}$ implies that $\sqrt{t} + p_n(t) \leq 2\sqrt{t} \leq 2$ for all $t \in [0, 1]$ (hence the right hand side is positive). Next, the recurrence relation implies that $p_{n+1}(t) \geq p_n(t)$ for all t . Then, for each $t \in [0, 1]$, $(p_n(t))_{n \geq 1}$ is increasing and bounded above by 1, hence convergent; let $p(t)$ be its limit. By passing to the limit in the recurrence relation we find that $p(t) = \sqrt{t}$.

We still have to show that p_n converges uniformly to p on $[0, 1]$. Let $\epsilon > 0$ and we look for N such that $p(t) - p_n(t) < \epsilon$ for all $n \geq N$ (note that $p - p_n$ is positive). Let $t \in [0, 1]$. Since $p_n(t) \rightarrow p(t)$, we find $N(t)$ such that $p(t) - p_n(t) < \epsilon/3$ for all $n \geq N(t)$. Since p and $p_{N(t)}$ are continuous, we find an open neighborhood $V(t)$ of t such that $|p(s) - p(t)| < \epsilon/3$ and similarly for $p_{N(t)}$, for all $s \in V(t)$. Note that, for each $s \in V(t)$ we have the desired inequality:

$$p(s) - p_{N(t)}(s) = (p(s) - p(t)) + (p(t) - p_{N(t)}(t)) + (p_{N(t)}(t) - p_{N(t)}(s)) < 3\frac{\epsilon}{3} = \epsilon.$$

Varying t , $\{V(t) : t \in [0, 1]\}$ will be an open cover of $[0, 1]$ hence we can extract an open subcover $\{V(t_1), \dots, V(t_k)\}$. Then $N(t) := \max\{N(t_1), \dots, N(t_k)\}$ does the job: for $n \geq N(t)$ and $t \in [0, 1]$, t belongs to some $V(t_i)$ and then

$$p(s) - p_n(s) \leq p(s) - p_{N(t_i)}(s) < \epsilon.$$

We now return to the theorem and we denote by $\overline{\mathcal{A}}$ the closure of \mathcal{A} . We claim that:

$$f, g \in \overline{\mathcal{A}} \implies \sup(f, g), \inf(f, g) \in \overline{\mathcal{A}},$$

where $\sup(f, g)$ is the function $x \mapsto \max\{f(x), g(x)\}$, and similarly $\inf(f, g)$. Since any $f \in \overline{\mathcal{A}}$ is the limit of a sequence in \mathcal{A} , we may assume that $f, g \in \mathcal{A}$. Since $\sup(f, g) = (f + g + |f - g|)/2$, $\inf(f, g) = (f + g - |f - g|)/2$ and \mathcal{A} is a vector space, it suffices to show that, for any $f \in \mathcal{A}$, $|f| \in \overline{\mathcal{A}}$. Since any continuous f is bounded (X is compact!), by dividing by a constant, we may assume that $f \in \mathcal{A}$ takes values in $[-1, 1]$. Using the polynomials p_n , since \mathcal{A} is a subalgebra, $f_n := p_n(f^2) \in \mathcal{A}$, and it converges uniformly to $p(f^2) = |f|$. Hence $|f| \in \overline{\mathcal{A}}$.

We need one more remark: for any $x, y \in X$ with $x \neq y$ and any $a, b \in \mathbb{R}$, there exists $f \in \mathcal{A}$ such that $f(x) = a$, $f(y) = b$. Indeed, by hypothesis, we find $g \in \mathcal{A}$ such that $g(x) \neq g(y)$; since \mathcal{A} contains the unit (hence all the constants),

$$f := a + \frac{b - a}{g(y) - g(x)}(g - g(x))$$

will be in \mathcal{A} and it clearly satisfies $f(x) = a$, $f(y) = b$.

Let now $h \in \mathcal{C}(X, \mathbb{R})$. Let $\epsilon > 0$ and we look for $f \in \mathcal{A}$ such that $d_{\sup}(h, f) \leq \epsilon$.

We first show that, for any $x \in X$, there exists $f_x \in \mathcal{A}$ such that $f_x(x) = h(x)$ and $f_x(y) < h(y) + \epsilon$ for all $y \in X$. For this, for any $y \in X$ we choose a function $f_{x,y} \in \mathcal{A}$ such that $f_{x,y}(x) = h(x)$ and $f_{x,y}(y) \leq h(y) + \epsilon/2$ (possible due to the previous step). Using continuity, we find a neighborhood $V(y)$ of y such that $f_{x,y}(y') < h(y') + \epsilon$ for all $y' \in V(y)$. From the cover $\{V(y) : y \in X\}$ we extract a finite subcover $\{V(y_1), \dots, V(y_k)\}$ and put

$$f_x := \inf\{f_{x,y_1}, \dots, f_{x,y_k}\}.$$

From the previous steps, $f_x \in \overline{\mathcal{A}}$; by construction, $f_x(y) < h(y) + \epsilon$ for all $y \in X$ and $f_x(x) = h(x)$. Due to the last equality, we find an open neighborhood $W(x)$ of x such that $f_x(x') > h(x') - \epsilon$ for all $x' \in W(x)$. We now let x vary and choose x_1, \dots, x_l such that $\{W(x_1), \dots, W(x_l)\}$ cover X . Finally, we put

$$f := \sup\{f_{x_1}, \dots, f_{x_l}\}.$$

By the discussion above, it belongs to $\overline{\mathcal{A}}$ while, by construction, $d_{\sup}(h, f) \leq \epsilon$. \square

The previous theorem does not hold (word by word) over \mathbb{C} instead of the reals. The appropriate complex-version of the Stone-Weierstrass theorem requires an extra-condition which refers precisely to the extra-structure present in the complex case: conjugation (hence the $*$ -algebra structure on $\mathcal{C}(X, \mathbb{C})$).

DEFINITION 8.15. *Given a unital $*$ -algebra A , a subalgebra $B \subset A$ is called a $*$ -subalgebra if*

$$b^* \in B \quad \forall b \in B.$$

With this, we have:

COROLLARY 8.16. *Let X be a compact Hausdorff space. Then any point-separating $*$ -subalgebra $\mathcal{A} \subset \mathcal{C}(X, \mathbb{C})$ is dense in $(\mathcal{C}(X, \mathbb{C}), d_{\sup})$.*

PROOF. Let $\mathcal{A}_{\mathbb{R}} := \mathcal{A} \cap \mathcal{C}(X, \mathbb{R})$. Since for any $f \in \mathcal{F}$,

$$\operatorname{Re}(f) = \frac{f + \bar{f}}{2}, \quad \operatorname{Im}(f) = \frac{f - \bar{f}}{2i}$$

belong to $\mathcal{A}_{\mathbb{R}}$, it follows that $\mathcal{A}_{\mathbb{R}}$ separates points and is a unital subalgebra of $\mathcal{C}(X, \mathbb{R})$. From the previous theorem, $\mathcal{A}_{\mathbb{R}}$ is dense in $\mathcal{C}(X, \mathbb{R})$. Hence $\mathcal{A} = \mathcal{A}_{\mathbb{R}} + i\mathcal{A}_{\mathbb{R}}$ is dense in $\mathcal{C}(X, \mathbb{C})$. \square

3. Recovering X from $\mathcal{C}(X)$: the Gelfand Naimark theorem

The Gelfand-Naimark theorem says that a compact Hausdorff space can be recovered from its algebra $\mathcal{C}(X)$ of continuous functions (using only the algebra structure!!!). Again, it makes no difference whether we work over \mathbb{R} or \mathbb{C} ; so let's just fix \mathbb{K} to be one of them and that we work over \mathbb{K} . The key ingredient in recovering X from $\mathcal{C}(X)$ is the notion of maximal ideal.

DEFINITION 8.17. Let A be an algebra. A ideal of A is any vector subspace $I \subset A$ satisfying

$$a \cdot x, x \cdot a \in I \quad \forall a \in A, x \in I.$$

The ideal I is called maximal if there is no other ideal J strictly containing I and different from A . We denote by M_A the set of all maximal ideals of A .

For instance, for $A = \mathcal{C}(X)$ (X a topological space), any subspace $A \subset X$ defines an ideal:

$$I_A := \{f \in \mathcal{C}(X) : f|_A = 0\}.$$

When $A = \{x\}$ is a point, we denote this ideal simply by I_x . Note that $I_A \subset I_x$ for all $x \in A$.

PROPOSITION 8.18. If X is a compact Hausdorff space, then I_x is a maximal ideal of $\mathcal{C}(X)$ for all $x \in X$, and any maximal ideal is of this type. In other words, one has a bijection

$$\phi : X \xrightarrow{\sim} M_{\mathcal{C}(X)}, \quad x \mapsto I_x.$$

PROOF. Fix $x \in X$ and we show that I_x is maximal. Let I be another ideal strictly containing I_x ; we prove $I = \mathcal{C}(X)$. Since $I \neq I_x$, we find $f \in I$ such that $f(x) \neq 0$. Since f is continuous, we find an open U such that $x \in U$, $f \neq 0$ on U . Now, $\{x\}$ and $X - U$ are two disjoint closed subsets of X hence, by Urysohn lemma, there exists $\eta \in \mathcal{C}(X)$ such that $\eta(x) = 0$, $\eta = 1$ outside U . Clearly, $\eta \in I_x \subset I$. Since I is an ideal containing f and η , $g := |f|^2 + \eta^2 \in I$. Note that $g > 0$: for $x \in U$, $f(x) \neq 0$, while for $x \in X - U$, $\eta(x) = 1$. But then any $h \in \mathcal{C}(X)$ is in I since it can be written as $g \frac{h}{g}$ with $g \in I$, $\frac{h}{g} \in \mathcal{C}(X)$. Hence $I = \mathcal{C}(X)$.

We still have to show that, if I is a maximal ideal, then $I = I_x$ for some x . It suffices to show that $I \subset I_x$ for some $x \in X$. Assume the contrary. Then, for any $x \in X$, we find $f_x \in I$ s.t. $f_x(x) \neq 0$. Since f_x is continuous, we find an open U_x s.t. $x \in U_x$, $f_x \neq 0$ on U_x . Now, $\{U_x : x \in X\}$ is an open cover of X . By compactness, we can select a finite subcover $\{U_{x_1}, \dots, U_{x_k}\}$. But then

$$g := |f_{x_1}|^2 + \dots + |f_{x_k}|^2 \in I$$

and $g > 0$ on X . By the same argument as above, we get $I = \mathcal{C}(X)$ - contradiction! \square

The proposition shows how to recover X from $\mathcal{C}(X)$ as a set. To recover the topology, it is useful to slightly change the point of view and look at characters instead of maximal ideals.

DEFINITION 8.19. Given an algebra A , a character of A is any \mathbb{K} -linear function $\chi : A \rightarrow \mathbb{K}$ which is not identically zero and satisfies

$$\chi(a \cdot b) = \chi(a)\chi(b) \quad \forall a, b \in A.$$

The set of characters of A is denoted by X_A and is called the spectrum of A . When we want to be more precise about \mathbb{K} , we talk about the real or the complex spectrum of A .

The previous proposition can be reformulated into:

COROLLARY 8.20. If X is a compact Hausdorff space then, for any $x \in X$,

$$\chi_x : \mathcal{C}(X) \rightarrow \mathbb{K}, \quad \chi_x(f) = f(x)$$

is a character of $\mathcal{C}(X)$, and any character is of this type. In other words, one has a bijection

$$\phi : X \xrightarrow{\sim} X_{\mathcal{C}(X)}, \quad x \mapsto \chi_x.$$

PROOF. The main observation is that characters correspond to maximal ideals. It should be clear that any χ_x is a character. Let now χ be an arbitrary character. Let $I := \{f \in \mathcal{C}(X) : \chi(f) = 0\}$ (an ideal- check that!). We will make use of the remark that

$$(3.1) \quad f - \chi(f) \cdot 1 \in I$$

for all $f \in \mathcal{C}(X)$ (indeed, all these elements are killed by χ). We show that I is maximal. Let J be another ideal strictly containing I . Choosing $f \in J$ not belonging to I (i.e. $\chi(f) \neq 0$) and using (3.1) and $I \subset J$, we find that $1 \in J$ hence, as above, $J = \mathcal{C}(X)$. This proves that I is maximal. We deduce that it is of type I_x for some $x \in X$. But then, using (3.1) again we deduce that $(f - \chi(f) \cdot 1)(x) = 0$ for all f , i.e. $\chi = \chi_x$. \square

The advantage of characters is that there is a natural topology on X_A for any algebra A .

DEFINITION 8.21. *Let A be an algebra A and let X_A be its spectrum. For any $a \in A$, define*

$$f_a : X_A \rightarrow \mathbb{K}, \quad f_a(\chi) := \chi(a).$$

We define \mathcal{T} as the smallest topology on X_A with the property that all the functions $\{f_a : a \in A\}$ are continuous. The resulting topological space (X_A, \mathcal{T}) is called the topological spectrum of A .

THEOREM 8.22. *Any compact Hausdorff space X is homeomorphic to the topological spectrum of its algebra $\mathcal{C}(X)$ of continuous functions.*

PROOF. Let \mathcal{T}_X be the topology of X . We still have to show that the bijection ψ is a homeomorphism. Equivalently: ψ induces a topology \mathcal{T}' on X which is the smallest topology with the property that all $f \in \mathcal{C}(X)$ are continuous as functions with respect to this new topology \mathcal{T}' . We have to show that \mathcal{T}' coincides with the original topology \mathcal{T}_X . From the defining property of \mathcal{T}' , the inclusion $\mathcal{T}' \subset \mathcal{T}_X$ is tautological. For the other inclusion, we have to use the more explicit description of \mathcal{T}' : it is the topology generated by the subsets of X of type $f^{-1}(V)$ with $f \in \mathcal{C}(X)$ and $V \subset \mathbb{K}$ open. We have to show that any $U \in \mathcal{T}_X$ is in \mathcal{T}' . Fixing U , it suffices to show that for any $x \in U$ we find f and V such that

$$x \in f^{-1}(V) \subset U.$$

But this follows again by the Urysohn lemma: we find $f : X \rightarrow [0, 1]$ continuous such that $f(x) = 0$ and $f = 1$ outside U . Taking $V = (-1, 1)$, we have the desired property. \square

REMARK 8.23. *(for the curious reader)* In this remark we work over $\mathbb{K} = \mathbb{C}$. An interesting question that we did not answer is: which algebras A are of type $\mathcal{C}(X)$ for some compact Hausdorff X ? What we did show is that the space must be X_A . Note also that the map ψ makes sense for any algebra A :

$$\psi_A : A \rightarrow \mathcal{C}(X_A), \quad a \mapsto (f_a : X_A \rightarrow \mathbb{C} \text{ given by } f_a(\chi) = \chi(a)).$$

Hence a possible answer is: algebras with the property that X_A is compact and Hausdorff, and ψ_A is an isomorphism (bijection). But this is clearly far from satisfactory.

The best answer is given by the full version of the Gelfand-Naimark theorem: it is the commutative C^* -algebras! This answer may seem a bit unfair since the notion of C^* -algebras seem to depend on data which is not algebraic (the norm!). However, a very special feature of C^* -algebras is that their norm can be recovered from the algebraic structure by the formula:

$$\|a\|^2 = \sup\{|\lambda| : \lambda \in \mathbb{C} \text{ such that } \lambda 1 - a^*a \text{ is not invertible}\}.$$

One remark about the proof: one first shows that X_A is compact and Hausdorff; then that $\|\psi_A(a)\| = \|a\|$ for all $a \in A$; this implies that ψ_A is injective and the image is closed in $\mathcal{C}(X_A)$; finally, the Stone-Weierstrass implies that the image is dense in $\mathcal{C}(X_A)$; hence ψ_A is bijective.

4. General function spaces $\mathcal{C}(X, Y)$

For any two topological spaces X and Y we denote by $\mathcal{C}(X, Y)$ the set of continuous functions from X to Y - a subset of the set $\mathcal{F}(X, Y)$ of all functions from X to Y . In general, there are several interesting topologies on $\mathcal{C}(X, Y)$. So far, in this chapter we were concerned with the uniform topology on $\mathcal{C}(X, Y)$ when X is compact and Hausdorff and $Y = \mathbb{R}$ or \mathbb{C} . In Section 9, Chapter 3, in the case when $X \subset \mathbb{R}$ was an interval and $Y = \mathbb{R}^n$, we looked at the three topologies: of pointwise convergence, of uniform convergence, and of uniform convergence on compacts.

In this section we look at generalizations of these topologies to the case when X and Y are more general topological spaces. We assume throughout this entire section that

X - is a locally compact topological space, Y - is a metric space with a fixed metric d .

These assumptions are not needed everywhere (e.g. for the pointwise topology on $\mathcal{C}(X, Y)$, the topology of X is completely irrelevant, etc etc). They are made in order to simplify the presentation.

4.1. Pointwise convergence, uniform convergence, compact convergence. Almost the entire Section 9, Chapter 3 goes through in this generality without any trouble ("word by word" most of the times). For instance, given a sequence $\{f_n\}_{n \geq 1}$ in $\mathcal{F}(X, Y)$, $f \in \mathcal{F}(X, Y)$, we will say that:

- f_n converges pointwise to f , and we write $f_n \xrightarrow{pt} f$, if $f_n(x) \rightarrow f(x)$ for all $x \in X$.
- f_n converges uniformly to f , and we write $f_n \rightrightarrows f$, if for any $\epsilon > 0$, there exists n_ϵ s.t.

$$d(f_n(x), f(x)) < \epsilon \quad \forall n \geq n_\epsilon, \quad \forall x \in X.$$

- f_n converges uniformly on compacts to f , and we write $f_n \xrightarrow{cp} f$ if, for any $K \subset X$ compact, $f_n|_K \rightrightarrows f|_K$.

And, as in *loc.cit* (with exactly the same proof), these convergences correspond to convergences with respect to the following topologies on $\mathcal{F}(X, Y)$:

- the pointwise topology, denoted \mathcal{T}_{pt} , is the topology generated by the family of subsets

$$S(x, U) := \{f \in \mathcal{F}(X, Y) : f(x) \in U\} \subset \mathcal{F}(X, Y),$$

with $x \in X$, $U \subset Y$ open.

- the uniform topology is induced by a sup-metric. For $f, g \in \mathcal{F}(X, Y)$, we define

$$d_{\text{sup}}(f, g) = \sup\{d(f(x), g(x)) : x \in X\}.$$

Again, to overcome the problem that this supremum may be infinite (for some f and g) and to obtain a true metric, one considers

$$\hat{d}_{\text{sup}}(f, g) = \min(d_{\text{sup}}(f, g), 1).$$

The uniform topology is the topology associated to \hat{d}_{sup} ; it is denoted by $\mathcal{T}_{\text{unif}}$.

- the topology of compact convergence, denoted \mathcal{T}_{cp} , is the topology generated by the family of subsets

$$B_K(f, \epsilon) := \{g \in \mathcal{F}(X, Y) : d(f(x), g(x)) < \epsilon \quad \forall x \in K\},$$

with $K \subset X$ compact, $\epsilon > 0$.

We will be mainly concerned with the restrictions of these topologies to the set $\mathcal{C}(X, Y)$ of continuous functions from X to Y . So, the part of Theorem 3.27 concerning continuous functions, with exactly the same proof, gives us the following:

THEOREM 8.24. *If (Y, d) is complete, then $(\mathcal{C}(X, Y), \hat{d}_{\text{sup}})$ is complete.*

4.2. Equicontinuity. A useful concept regarding function spaces is equicontinuity. Recall that X is a locally compact space and (Y, d) is a metric space. Then a function $f : X \rightarrow Y$ is continuous if it is continuous at each point, i.e. if for each $x_0 \in X$ and any $\epsilon > 0$ there exists a neighborhood V of x_0 such that

$$(4.1) \quad d(f(x), f(x_0)) < \epsilon \quad \forall x \in U.$$

DEFINITION 8.25. A subset $\mathcal{F} \subset \mathcal{C}(X, Y)$ is called equicontinuous if for any $x_0 \in X$ and any $\epsilon > 0$ there exists a neighborhood V of x_0 such that (4.1) holds for all $f \in \mathcal{F}$.

When X is itself a metric space, then there is a “uniform” version of continuity and equicontinuity.

DEFINITION 8.26. Assume that both (X, d) and (Y, d) are metric spaces. Then

1. A map $f : X \rightarrow Y$ is called uniformly continuous if for all $\epsilon > 0$ there exists $\delta > 0$ s.t.

$$(4.2) \quad d(f(x), f(y)) < \epsilon \quad \forall x, y \in X \text{ with } d(x, y) < \delta.$$

2. A subset $\mathcal{F} \subset \mathcal{C}(X, Y)$ is called uniformly equicontinuous if for all $\epsilon > 0$ there exists $\delta > 0$ s.t. (4.2) holds for all $f \in \mathcal{F}$.

From the definitions we immediately see that, in general, the following implications hold:

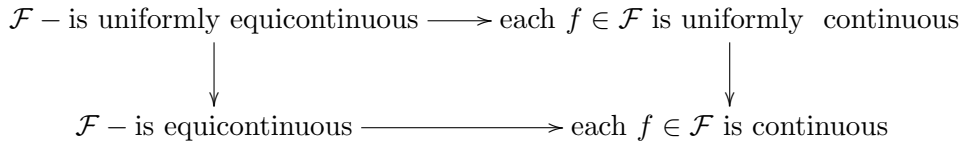

As terminology, we say that a sequence $(f_n)_{n \geq 1}$ is equicontinuous if the set $\{f_n : n \geq 1\}$ is.

PROPOSITION 8.27. A sequence $\{f_n\}_{n \geq 1}$ is convergent in $(\mathcal{C}(X, Y), \mathcal{T}_{cp})$ if and only if it is convergent in $(\mathcal{C}(X, Y), \mathcal{T}_{pt})$ and it is equicontinuous.

PROOF. For the direct implication, we still have to show that, if $f_n \xrightarrow{cp} f$, then $\{f_n\}$ is equicontinuous. Let $x_0 \in X$. Since f is continuous, we find a neighborhood V of x_0 such that $d(f(x), f(x_0)) < \epsilon/3$ for all $x \in V$. Since X is locally compact, we may assume V to be compact. Then $f_n|_V \rightrightarrows f|_V$ hence we find n_ϵ such that $d(f_n(x), f(x)) < \epsilon/3$ for all $n \geq n_\epsilon, x \in V$. Then

$$d(f_n(x), f_n(x_0)) \leq d(f_n(x), f(x)) + d(f(x), f(x_0)) + d(f(x_0), f_n(x_0)) < \epsilon.$$

for all $x \in V$ and $n \geq n_\epsilon$. By making V smaller if necessary, the previous inequality will also hold for all $n < n_\epsilon$ (since there are a finite number of such n 's, and each f_n is continuous).

We now prove the converse. Assume equicontinuity and assume that $f_n \rightarrow f$ pointwise. Let $K \subset X$ be compact; we prove that $f_n|_K \rightrightarrows f|_K$. Let $\epsilon > 0$. For each $x \in K$, there is an open V_x containing x , such that

$$d(f_n(y), f_n(x)) < \epsilon/3 \quad \forall y \in V_x, \forall n.$$

Since $\{V_x\}$ covers the compact K , we find a finite number of points $x_i \in K$ (with $1 \leq i \leq k$) such that the opens $V_i = V_{x_i}$ cover K . Since $f_n(x_i) \rightarrow f(x_i)$, we find n_ϵ such that

$$d(f_n(x_i), f(x_i)) < \epsilon/3 \quad \forall n \geq n_\epsilon \forall i \in \{1, \dots, k\}.$$

Now, for all $n \geq n_\epsilon$ and $x \in K$, choosing i such that $x \in V_i$, we have

$$d(f_n(x), f(x)) \leq d(f_n(x), f_n(x_i)) + d(f_n(x_i), f(x_i)) + d(f(x_i), f(x)) < 3 \frac{\epsilon}{3} = \epsilon.$$

(here we used that $d(f(x_i), f(x)) = \lim_n d(f_n(x_i), f_n(x)) \leq \epsilon/3$). □

4.3. Boundedness. Let's also briefly discuss boundedness. For $\mathcal{F} \subset \mathcal{C}(X, Y)$ and $x \in X$ we use the notation

$$\mathcal{F}(x) := \{f(x) : f \in \mathcal{F}\}.$$

As we have already discussed, in a metric space, there is also the notion of “totally bounded”, which is an improvement of the notion of “bounded”. Also, in our case we can talk about boundedness (and totally boundedness) with respect to \hat{d}_{sup} , or we can have pointwise versions (with respect to the metric d of Y). In total, four possibilities:

DEFINITION 8.28. We say that $\mathcal{F} \subset \mathcal{C}(X, Y)$ is:

- Bounded if it is bounded in $(\mathcal{C}(X, Y), \hat{d}_{\text{sup}})$.
- Totally bounded if it is totally bounded in $(\mathcal{C}(X, Y), \hat{d}_{\text{sup}})$.
- Pointwise bounded if $\mathcal{F}(x)$ is bounded in (Y, d) for all $x \in X$.
- Pointwise totally bounded if $\mathcal{F}(x)$ is totally bounded in (Y, d) for all $x \in X$.

From the definitions we immediately see that, in general, the following implications hold:

$$\begin{array}{ccc} \text{totally bounded} & \longrightarrow & \text{bounded} \\ \downarrow & & \downarrow \\ \text{pointwise totally bounded} & \longrightarrow & \text{pointwise bounded} \end{array}$$

EXAMPLE 8.29. For $Y = \mathbb{R}^n$ with the Euclidean metric d , since totally boundedness and boundedness in (\mathbb{R}^n, d) are equivalent, we see that a subset $\mathcal{F} \subset \mathcal{C}(X, \mathbb{R}^n)$ is pointwise totally bounded if and only if it is pointwise bounded. However, it is not true that \mathcal{F} is totally bounded if and only if it is bounded. In general, totally boundedness implies equicontinuity:

PROPOSITION 8.30. If $\mathcal{F} \subset \mathcal{C}(X, Y)$ is totally bounded then it must be equicontinuous. Moreover, if each $f \in \mathcal{F}$ is uniformly continuous, then \mathcal{F} is even uniformly equicontinuous.

PROOF. Fix $\epsilon > 0$ and $x_0 \in X$. By assumption, we find $f_1, \dots, f_k \in \mathcal{F}$ such that

$$\mathcal{F} \subset B(f_1, \epsilon/3) \cup \dots \cup B(f_k, \epsilon/3),$$

where the balls are the ones corresponding to \hat{d}_{sup} . Since each f_i is continuous, we find a neighborhood U_i of f_i such that

$$d(f_i(x), f_i(x_0)) < \epsilon/3, \quad \forall x \in U_i.$$

Then $U = \cap_i U_i$ is a neighborhood of x_0 . For $x \in U$, $f \in \mathcal{F}$, choosing i s.t. $f \in B(f_i, \epsilon/3)$:

$$d(f(x), f(x_0)) \leq d(f(x), f_i(x_0)) + d(f_i(x), f_i(x_0)) + d(f_i(x_0), f(x_0)),$$

which is $< \epsilon$ (for all $x \in U$, $f \in \mathcal{F}$). This proves equicontinuity. For the second part the argument is completely similar (even simpler as all U_i will become X), where we use that each f_i is uniformly continuous. \square

Let us also recall that the notion of totally boundedness was introduced in order to characterize compactness. Since \hat{d}_{sup} is complete whenever (Y, d) is (Theorem 8.24) we deduce:

PROPOSITION 8.31. A subset $\mathcal{F} \subset \mathcal{C}(X, Y)$ is totally bounded if and only if it is relatively compact in $(\mathcal{C}(X, Y), \hat{d}_{\text{sup}})$.

4.4. The case when X is a compact metric space. When X is a compact metric space the situation simplifies quite a bit. In some sense, the pointwise conditions imply the uniform ones (in the vertical implications from the previous two diagrams). To be more precise, let us combine the two diagrams and Proposition 8.30 together into a diagram of implications:

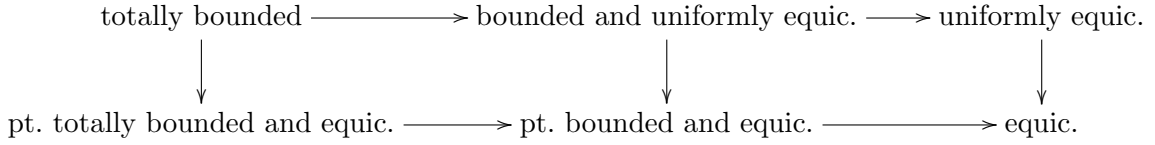

where “pt.” stands for pointwise and “equic.” for equicontinuous. Of course, we could have continued to the right with “each $f \in \mathcal{F}$ is (uniformly) continuous”. We are looking at the converses of the vertical implications. The first one is of the next subsection. For the rest:

THEOREM 8.32. *If (X, d) is a compact metric space, $f : X \rightarrow Y$, $\mathcal{F} \subset \mathcal{C}(X, Y)$, then*

1. *(f is continuous) \iff (f is uniformly continuous).*
2. *(\mathcal{F} is equicontinuous) \iff (\mathcal{F} is uniformly equicontinuous). In this case, moreover,*
 - a. *(\mathcal{F} is pointwise bounded) \iff (\mathcal{F} is bounded).*
 - b. *$\mathcal{T}_{\text{unif}}$ and \mathcal{T}_{pt} induce the same topology on \mathcal{F} .*

In particular, if a sequence $(f_n)_{n \geq 1}$ is equicontinuous, then it is uniformly convergent (or bounded) iff it is pointwise convergent (or pointwise bounded, respectively).

PROOF. For 1, 2 and (a) the nontrivial implications are the direct ones. For 1, assume that f is continuous. Let $\epsilon > 0$. For each $x \in X$ choose V_x such that

$$d(f(y), f(x)) < \epsilon/2 \quad \forall y \in V_x.$$

Apply now the Lebesgue lemma (Proposition 6.10) and let $\delta > 0$ be a resulting Lebesgue number. Then, for each $y, z \in X$ with $d(y, z) < \delta$ we find $x \in X$ such that $y, z \in V_x$, hence

$$d(f(y), f(z)) \leq d(f(y), f(x)) + d(f(z), f(x)) < \epsilon.$$

This proves that f is uniformly continuous. Exactly the same proof applies to 2 (just add “for all $f \in \mathcal{F}$ ” everywhere). For (a), assume that \mathcal{F} is equicontinuous and pointwise bounded. From the first condition we find an open cover $\{V_x\}_{x \in X}$ with $x \in V_x$ and $d(f(y), f(x)) < 1$ for all $y \in V_x$. Choose a finite subcover corresponding to $x_1, \dots, x_k \in X$. Using that $\mathcal{F}(x_i)$ is bounded for each i , we find $M > 0$ such that

$$d(f(x_i), g(x_i)) < M \quad \forall f, g \in \mathcal{F}, \quad \forall 1 \leq i \leq k.$$

Then, for arbitrary $x \in X$, choosing i such that $x \in V_{x_i}$, we have

$$d(f(x), g(x)) \leq d(f(x), f(x_i)) + d(f(x_i), g(x_i)) + d(g(x_i), g(x)) < M + 2,$$

for all $f, g \in \mathcal{F}$, showing that \mathcal{F} is bounded. For (b), the non-obvious part is to show that $\mathcal{T}_{\text{unif}}|_{\mathcal{F}} \subset \mathcal{T}_{\text{pt}}|_{\mathcal{F}}$. Due to the definitions of these topologies, we start with $f \in \mathcal{F}$ and a ball

$$B_{\mathcal{F}}(f, \epsilon) = \{g \in \mathcal{F} : d_{\text{sup}}(g, f) < \epsilon\},$$

and we are looking for $x_1, \dots, x_k \in X$ and $\epsilon_1, \dots, \epsilon_k > 0$ such that

$$\cap_i \{g \in \mathcal{F} : d(g(x_i), f(x_i)) < \epsilon_i\} \subset B_{\mathcal{F}}(f, \epsilon).$$

For that, choose as before a finite open cover $\{V_{x_i}\}$ of X such that

$$d(f(x), f(x_i)) < \epsilon/6 \quad \forall f \in \mathcal{F}, \quad x \in V_{x_i}$$

and, by the same inequalities as above, we find that the x_i and $\epsilon_i = \epsilon/3$ have the desired properties. \square

4.5. The Arzela-Ascoli theorem. The Arzela-Ascoli theorem has quite a few different looking versions. They all give compactness criteria for subspaces of $\mathcal{C}(X, Y)$ in terms of equicontinuity; sometimes the statement is a sequential one (giving criteria for an equicontinuous sequence to admit a convergent subsequence). The difference between the several versions comes either from the starting hypothesis on X and Y , or from the topologies one considers on $\mathcal{C}(X, Y)$. As in the last subsections, we restrict ourselves to the case that X and Y are metric and X is compact; the interesting topology on the space of functions will then be the uniform one.

THEOREM 8.33. (*Arzela-Ascoli*) *Assume that (X, d) is a compact metric space, (Y, d) is complete. Then, for a subset $\mathcal{F} \subset \mathcal{C}(X, Y)$, the following are equivalent:*

1. \mathcal{F} is relatively compact in $(\mathcal{C}(X, Y), d_{sup})$.
2. \mathcal{F} is equicontinuous and pointwise totally bounded.

(note: when $Y = \mathbb{R}^n$ with the Euclidean metric, “pointwise totally bounded” = “pointwise bounded”).

COROLLARY 8.34. *Let X and Y be as above. Then any sequence $(f_n)_{n \geq 1}$ which is equicontinuous and pointwise totally bounded admits a subsequence which is uniformly convergent.*

PROOF. The direct implication is clear now: if $\overline{\mathcal{F}}$ is compact, it must be totally bounded (cf. Theorem 6.7); this implies that $\overline{\mathcal{F}}$ (hence also \mathcal{F}) is equicontinuous and pointwise bounded. We now prove the converse. Let us assume for simplicity that \mathcal{F} is also closed with respect to the uniform topology (otherwise replace it by its closure and, by the same arguments as before, show that equicontinuity and pointwise totally boundedness hold for the closure as well). We show that \mathcal{F} is compact. Using Theorem 6.7, it suffices to show that \mathcal{F} is sequentially compact. So, let $(f_n)_{n \geq 1}$ be a sequence in \mathcal{F} and we will show that it contains a convergent subsequence. Use Corollary 6.9 and consider

$$A = \{a_1, a_2, \dots\} \subset X$$

which is dense in X . Since $(f_n(a_1))_{n \geq 1}$ is totally bounded, using Corollary 6.8, it follows that it has a convergent subsequence $(f_n(a_1))_{n \in I_1}$, where $I_1 \subset \mathbb{Z}_+$. Let n_1 be the smallest element of I_1 . Similarly, since $(f_n(a_2))_{n \in I_1}$ is totally bounded, we find a convergent subsequence $(f_n(a_2))_{n \in I_2}$ where $I_2 \subset I_1$. Let n_2 be the smallest element of I_2 . Continue inductively to construct I_j and its smallest element n_j for all j . Choosing $g_k = f_{n_k}$, this will be a subsequence of (f_n) which has the property that $(g_k(a_i))_{k \geq 1}$ is convergent for all i . We will show that (g_k) is Cauchy (hence convergent). Let $\epsilon > 0$. Since \mathcal{F} is uniformly equicontinuous, we find δ such that

$$d(g_k(x), g_k(y)) < \epsilon/3 \quad \forall k \text{ and whenever } d(x, y) < \delta.$$

Since A is dense in X , the balls $B(a_i, \delta)$ cover X ; since X is compact, we find some integer N such that X is covered by $B(a_i, \delta)$ with $1 \leq i \leq N$. Since each of the sequences $(g_k(a_i))_{k \geq 1}$ is convergent for all $1 \leq i \leq N$, we find n_ϵ such that

$$d(g_j(a_i), g_k(a_i)) < \epsilon/3 \quad \forall j, k \geq n_\epsilon \quad \forall 1 \leq i \leq N.$$

Then, for all $x \in X$, $j, k \geq n_\epsilon$, choosing $i \leq N$ such that $x \in B(a_i, \delta)$, we have

$$d(g_j(x), g_k(x)) \leq d(g_j(x), g_j(a_i)) + d(g_j(a_i), g_k(a_i)) + d(g_k(a_i), g_k(x)) < \epsilon.$$

□

Finally, let us also mention the following more general version of the Arzela-Ascoli (see Munkres' book).

THEOREM 8.35. (*Arzela-Ascoli*) *Assume that X is a locally compact Hausdorff space, (Y, d) is a complete metric space, $\mathcal{F} \subset \mathcal{C}(X, Y)$. Then \mathcal{F} is relatively compact in $(\mathcal{C}(X, Y), \mathcal{T}_{cp})$ if and only if \mathcal{F} is equicontinuous and pointwise totally bounded.*

In particular, any sequence $(f_n)_{n \geq 1}$ in $\mathcal{C}(X, \mathbb{R}^N)$ which is equicontinuous and pointwise totally bounded admits a subsequence which is uniformly convergent on compacts.

5. More exercises

5.1. On Stone-Weierstrass.

EXERCISE 8.1. Show that $C^\infty([0, 1])$ (the space of real-valued functions on $[0, 1]$ which are infinitely many times differentiable) is dense in $C([0, 1])$.

EXERCISE 8.2. On the sphere S^2 we consider the real-valued functions

$$f(x, y, z) = x + y + z, g(x, y, z) = xy + yz + zx.$$

Does $\{f, g\}$ separate points? What if we add the function $h(x, y, z) = xyz$?

EXERCISE 8.3. Let X be a compact topological space. Show that if a finite set of continuous functions

$$\mathcal{A} = \{f_1, \dots, f_k\} \subset C(X)$$

separates points, then X can be embedded in \mathbb{R}^k .

EXERCISE 8.4. Consider the 3-dimensional sphere interpreted as:

$$S^3 = \{(z_1, z_2) \in \mathbb{C}^2 : |z_1|^2 + |z_2|^2 = 1\}.$$

Consider the circle $S^1 = \{z \in \mathbb{C} : |z| = 1\}$, viewed as a group with respect to the multiplication of complex numbers, and we consider the action of S^1 on S^3 given by

$$z \cdot (z_1, z_2) := (zz_1, \bar{z}z_2).$$

Let $X := S^3/S^1$. Consider $\tilde{f}, \tilde{g}, \tilde{h} : S^3 \rightarrow \mathbb{R}$ given by

$$\tilde{f}(z_1, z_2) = z_1 z_2 + \bar{z}_1 \bar{z}_2, \tilde{g}(z_1, z_2) = i(z_1 z_2 - \bar{z}_1 \bar{z}_2), \tilde{h}(z_1, z_2) = |z_1|^2 - |z_2|^2.$$

Show that

1. $\tilde{f}, \tilde{g}, \tilde{h}$ induce functions $f, g, h : X \rightarrow \mathbb{R}$.
2. $\{f, g, h\}$ separates points.
3. The image of the resulting embedding $(f, g, h) : X \rightarrow \mathbb{R}^3$ is S^2 .

EXERCISE 8.5. If K is a compact subspace of \mathbb{R}^n , show that the space $\text{Pol}(K)$ of polynomial functions on K is dense in $C(K)$ in the uniform topology.

(recall that a function $f : K \rightarrow \mathbb{R}^n$ is polynomial if there exists a polynomial $P \in \mathbb{R}[X_1, \dots, X_n]$ such that $f(x) = P(x)$ for all $x \in K$).

EXERCISE 8.6. Show that, if $f : \mathbb{R} \rightarrow \mathbb{R}$ is continuous and periodic of period 2π , then f can be realized as the limit of a sequence of functions of type

$$T(x) = a_0 + \sum_{k=1}^N (a_k \cos(kx) + b_k \sin(kx)).$$

EXERCISE 8.7. Show that, for any compact smooth manifold X , $C^\infty(X)$ is dense in $C(X)$.

5.2. On Gelfand-Naimark.

EXERCISE 8.8. Consider the algebra $A = \mathbb{R}[t]$ of polynomials in one variable t . Show that X_A is homeomorphic to \mathbb{R} . What if you take more variables?

EXERCISE 8.9. Consider

$$A = \mathbb{R}[X, Y]/(X^2 + Y^2 - 1)$$

(the quotient of the ring of polynomials in two variables, modulo the ideal generated by $f = X^2 + Y^2 - 1$ or, equivalently, the ring of remainders modulo f). Interpret it as an algebra over \mathbb{R} and show that X_A is homeomorphic to S^1 . (Hint: Let $\alpha, \beta \in A$ corresponding to X and Y .)

Then a character χ is determined by $u = \chi(\alpha)$ and $v = \chi(\beta)$. What do they must satisfy? Also, have a look back at Exercise 3.33).

(if you do not understand the above definition of A , take as definition $A :=$ the algebra of polynomial functions on $S^1 \subset \mathbb{R}^2$ and then α and β in the hint are the first and second projection).

EXERCISE 8.10. Consider the algebra $A = \mathbb{R}[t]/(t^3)$ (remainders modulo t^3). Compute X_A .

EXERCISE 8.11. Consider the algebra

$$A = \{f \in \mathcal{C}(S^n) : f(z) = f(-z) \quad \forall z \in S^n\}.$$

Show that X_A is homeomorphic to \mathbb{P}^n .

EXERCISE 8.12. More generally, if a finite group Γ acts on a compact space X , consider

$$A = \mathcal{C}(X)^\Gamma := \{f \in \mathcal{C}(X) : f(\gamma \cdot x) = f(x) \quad \forall x \in X, \gamma \in \Gamma\}$$

and compute X_A .

CHAPTER 9

Embedding theorems

In this chapter we will describe a general method for attacking embedding problems. We will establish several results but, as the main final result, we state here the following:

THEOREM 9.1. *Any compact n -dimensional topological manifold can be embedded in \mathbb{R}^{2n+1} .*

1. **Using function spaces**
2. **Using covers and partitions of unity**
3. **Dimension and open covers**
4. **More exercises**

1. Using function spaces

Throughout this section (X, d) is a metric space which is assumed to be compact and Hausdorff, and (Y, d) is a complete metric space (which, for the purpose of the chapter, you may assume to be \mathbb{R}^n with the Euclidean metric). The associated embedding problem is: can X be embedded in (Y, \mathcal{T}_d) . Since X is compact, this is equivalent to the existence of a continuous injective function $f : X \rightarrow Y$.

DEFINITION 9.2. Given $f \in \mathcal{C}(X, Y)$, the injectivity defect of f is defined as

$$\delta(f) := \sup \{d(x, x') : x, x' \in X \text{ such that } f(x) = f(x')\}.$$

For each $\epsilon > 0$, we defined the space of ϵ -approximately embeddings of X in Y as:

$$\text{Emb}_\epsilon(X, Y) := \{f \in \mathcal{C}(X, Y) : \delta(f) < \epsilon\}$$

endowed with the topology of uniform convergence.

PROPOSITION 9.3. If $\text{Emb}_\epsilon(X, Y)$ is dense in $\mathcal{C}(X, Y)$ with respect to the uniform topology, for all $\epsilon > 0$, then there exists an embedding of X in Y .

PROOF. The space $\text{Emb}(X, Y)$ of all embeddings of X in Y can be written as

$$\text{Emb}(X, Y) = \bigcap_n \text{Emb}_{1/n}(X, Y)$$

where the intersection is over all positive integers. Since (Y, d) is complete, Theorem 8.24 implies that $(\mathcal{C}(X, Y), d_{\text{sup}})$ is complete. By Proposition 6.3, it will have the Baire property. Hence, it suffices to show that the spaces $\text{Emb}_\epsilon(X, Y)$ are open in $\mathcal{C}(X, Y)$ (and then it follows not only that $\text{Emb}(X, Y)$ is non-empty, but actually dense in $\mathcal{C}(X, Y)$).

So, let $\epsilon > 0$ and we show that $\text{Emb}_\epsilon(X, Y)$ is open. Let $f \in \text{Emb}_\epsilon(X, Y)$ arbitrary; we are looking for δ such that

$$B_{d_{\text{sup}}}(f, \delta) = \{g \in \mathcal{C}(X, Y) : d_{\text{sup}}(g, f) < \delta\}$$

is inside $\text{Emb}_\epsilon(X, Y)$. We first claim that there exists δ such that

$$(1.1) \quad d(f(x), f(y)) < 2\delta \implies d(x, y) < \epsilon.$$

If no such δ exists, we would find sequences (x_n) and (y_n) in X with

$$d(f(x_n), f(y_n)) \rightarrow 0, \quad d(x_n, y_n) \geq \epsilon.$$

Hence (as we have already done several times by now), after eventually passing to convergent subsequences, we may assume that (x_n) and (y_n) are convergent, with limits denoted x and y . It follows that

$$d(f(x), f(y)) = 0, \quad d(x, y) \geq \epsilon,$$

which is in contradiction with $f \in \text{Emb}_\epsilon(X, Y)$. Hence we do find δ satisfying (1.1). We claim that δ has the desired property; hence let $g \in B_{d_{\text{sup}}}(f, \delta)$ and we prove that $g \in \text{Emb}_\epsilon(X, Y)$. Note that

$$\delta(g) = \sup \{d(x, x') : x, x' \in K(g)\}$$

where $K(f) \subset X \times X$ consists of pairs (x, x') with $g(x) = g(x')$. Since g is continuous, $K(f)$ is closed in $X \times X$; since X is compact, it follows that $K(f)$ is compact; hence the above supremum will be attained at some $x, x' \in K(g)$. But for such x and x' :

$$d(f(x), f(x')) \leq d(f(x), g(x)) + d(g(x'), f(x')) + d(g(x), g(x')) < 2\delta$$

hence, by (1.1), $d(x, x') < \epsilon$; hence $\delta(g) < \epsilon$. □

2. Using covers and partitions of unity

In this section we assume that (X, d) is a compact metric space and $Y = \mathbb{R}^N$ is endowed with the Euclidean metric (where $N \geq 1$ is some integer). For the resulting embedding problem, we use the result of the previous section. We fix

$$f \in \mathcal{C}(X, \mathbb{R}^N), \quad \epsilon, \delta > 0$$

and we search for $g \in \mathcal{C}(X, Y)$ with $\delta(g) < \epsilon$, $d_{\text{sup}}(f, g) < \delta$. The idea is to look for g of type

$$(2.1) \quad g(x) = \sum_{i=1}^p \eta_i(x) z_i,$$

where $\{\eta_i\}$ is a continuous partition of unity and $z_i \in \mathbb{R}^N$ some points. To control $\delta(g)$, the points z_i have to be chosen in “the most general” position.

DEFINITION 9.4. *We say that a set $\{z_1, \dots, z_p\}$ of points in \mathbb{R}^N is in the general position if, for any $\lambda_1, \dots, \lambda_p \in \mathbb{R}$ from which at most $N + 1$ are non-zero, one has:*

$$\sum_{i=1}^p \lambda_i z_i = 0, \quad \sum_{i=1}^p \lambda_i = 0 \implies \lambda_i = 0 \quad \forall i \in \{1, \dots, p\}.$$

We now return to our problem. Recall that, for a subset A of a metric space (X, d) , $\text{diam}(A)$ is $\sup\{d(a, b) : a, b \in A\}$. For a family $\mathcal{A} = \{A_i : i \in I\}$, denote by $\text{diam}(\mathcal{A})$ the the supremum of $\{\text{diam}(A_i)$ with $i \in I\}$. In the following, we control $\delta(g)$.

LEMMA 9.5. *Let $\mathcal{U} = \{U_i\}$ be an open cover of X , $\{\eta_i\}$ a partition of unity subordinated to \mathcal{U} and $\{z_i\}$ a set of points in \mathbb{R}^N in general position, all indexed by $i \in \{1, \dots, p\}$. Assume that, for some integer m , each point in X lies in at most $m + 1$ members of \mathcal{U} . If $N \geq 2m + 1$ then the resulting function g given by (2.1) satisfies $\delta(g) \leq \text{diam}(\mathcal{U})$.*

PROOF. Assume that $g(x) = g(y)$, i.e. $\sum_{i=1}^p (\eta_i(x) - \eta_i(y)) z_i = 0$. Now, x lies in at most $m + 1$ members of \mathcal{U} , so at most $m + 1$ numbers from $\{\eta_i(x) : 1 \leq i \leq p\}$ are non-zero. Similarly for y . Hence at most $2(m + 1)$ coefficients $\eta_i(x) - \eta_i(y)$ are non-zero. Note also that the sum of these coefficients is zero. Hence, since $\{z_1, \dots, z_p\}$ is in general position and $2(m + 1) \leq N + 1$, it follows that $\eta_i(x) = \eta_i(y)$ for all i . Choosing i such that $\eta_i(x) > 0$, it follows that $x, y \in U_i$, hence $d(x, y) \leq \text{diam}(U_i)$. \square

Next, we control $d_{\text{sup}}(f, g)$. We use the notation $f(\mathcal{U}) = \{f(U) : U \in \mathcal{U}\}$.

LEMMA 9.6. *Let $\mathcal{U} = \{U_i\}$ be an open cover of X , $\{\eta_i\}$ a partition of unity subordinated to \mathcal{U} and $\{z_i\}$ a set of points in \mathbb{R}^N , all indexed by $i \in \{1, \dots, p\}$. Assume that, for some $r > 0$,*

$$\text{diam}(f(\mathcal{U})) < r, \quad d(z_i, f(U_i)) < r \quad \forall i \in \{1, \dots, p\}.$$

Then the resulting function g given by (2.1) satisfies $d_{\text{sup}}(f, g) < 2r$.

PROOF. Since $d(z_i, f(U_i)) < r$ we find $x_i \in U_i$ with $\|z_i - f(x_i)\| < r$. Writing

$$g(x) - f(x) = \sum_i \eta_i(x) (z_i - f(x_i)) + \sum_i \eta_i(x) (f(x_i) - f(x)),$$

$$\|g(x) - f(x)\| \leq \sum_i \eta_i(x) \|z_i - f(x_i)\| + \sum_i \eta_i(x) \|f(x_i) - f(x)\|.$$

Here each $\|z_i - f(x_i)\| < r$ by hypothesis, hence the first sum is $< r$. For the second sum note that, whenever $\eta_i(x) \neq 0$, we must have $x \in U_i$ hence, $\|f(x_i) - f(x)\| < r$. Hence also the second sum is $< r$, proving that $\|g(x) - f(x)\| < 2r$ for all $x \in X$. Since X is compact, we have $d_{\text{sup}}(f, g) < 2r$. \square

Next, we show the existence of “small enough” covers of X and points in \mathbb{R}^N in general position.

PROPOSITION 9.7. *For $\epsilon, \delta > 0$ there exists an open cover $\mathcal{U} = \{U_i : 1 \leq i \leq p\}$ of X with*

$$\text{diam}(\mathcal{U}) < \epsilon, \quad \text{diam}(f(\mathcal{U})) < \delta/2.$$

Moreover, for any such cover, there exist points $\{z_1, \dots, z_p\}$ in \mathbb{R}^N in general position such that

$$d(z_i, f(U_i)) < \delta/2 \quad \forall i \in \{1, \dots, p\}.$$

In particular, g given by (2.1) satisfies $\delta(g) < \epsilon$ and $d_{\text{sup}}(f, g) < \delta$, provided \mathcal{U} has the property that each point in X lies in at most $m + 1$ members of \mathcal{U} , where m satisfies $N \geq 2m + 1$.

PROOF. For the first part we use that f is uniformly continuous and choose $r < \epsilon$ such that

$$d(x, y) < r \implies d(f(x), f(y)) < \frac{\delta}{2}.$$

Consider then the open cover of X by balls of radius r (or any other arbitrarily smaller radius) and choose a finite subcover. For the second part, we choose $x_i \in U_i$ arbitrary and set $y_i = f(x_i) \in \mathbb{R}^N$. We prove that, in general, for any finite set $\{y_1, \dots, y_p\}$ of points in \mathbb{R}^N and any $r > 0$, there exists a set $\{z_1, \dots, z_p\}$ of points in general position such that $d(z_i, y_i) < r$ for all i . We proceed by induction on p . Assume the statement holds up to p and we prove it for $p + 1$. So, let $\{y_1, \dots, y_{p+1}\}$ be points in \mathbb{R}^N . From the induction hypothesis, we may assume that $\{y_1, \dots, y_p\}$ is already in general position. For each $I \subset \{1, \dots, p\}$ of cardinality at most N we consider the “hyperplane”

$$\mathcal{H}_I := \left\{ \sum_{i \in I} \lambda_i y_i : \lambda_i \in \mathbb{R}, \sum_{i \in I} \lambda_i = 1 \right\}.$$

Since $|I| \leq N$, each such hyperplane has empty interior (why?), hence so does their union $\cup_I \mathcal{H}_I$ taken over all I s as above. Hence $B(y_{p+1}, r)$ will contain an element z_{p+1} which is not in this intersection. It is not difficult to check now that $\{y_1, \dots, y_p, z_{p+1}\}$ is in general position. \square

3. Dimension and open covers

As in the previous section, we fix a compact metric space (X, d) and $Y = \mathbb{R}^N$ with the Euclidean metric. We assume that $N = 2m + 1$ for some integer m . Proposition 9.7 almost completes the proof of the existence of an embedding of X in \mathbb{R}^{2m+1} ; what is missing is to make sure that the covers \mathcal{U} from the proposition can be chosen so that each point in X lies in at most $m + 1$ members of \mathcal{U} . Note however that this is an important demand. After all, all that we have discussed applies to any compact metric space X (e.g. S^5) and any \mathbb{R}^N (e.g. $\mathbb{R}!$); this extra-demand is the only one placing a condition on N in terms of the topology of X . Actually, this is about “the dimension” of X .

DEFINITION 9.8. *Let X be a topological space, $m \in \mathbb{Z}_+$. We say that X has dimension less or equal to m , and we write $\dim(X) \leq m$, if any open cover \mathcal{U} admits an open refinement \mathcal{V} of multiplicity $\text{mult}(\mathcal{V}) \leq m + 1$, i.e. with the property that each $x \in X$ lies in at most $m + 1$ members of \mathcal{V} .*

The dimension of X is the smallest m with this property.

With this, Proposition 9.7 and Proposition 9.3 give us immediately:

COROLLARY 9.9. *Any compact metric space X with $\dim(X) \leq m$ can be embedded in \mathbb{R}^{2m+1} .*

Of course, this nice looking corollary is rather cheap at this point: it looks like we just defined the dimension of a space, so that the corollary holds. However, the definition of dimension given above is not at all accidental. By the way, did you ever think how to define the (intuitively clear) notion of dimension by making use only of the topological information? What are the properties of the opens that make \mathbb{R} one-dimensional and \mathbb{R}^2 two-dimensional? You may then discover yourself the previous definition. Of course, one should immediately prove that $\dim(\mathbb{R}^N)$ is indeed N or, more generally, that any m -dimensional topological manifold X has $\dim(X) = m$. These are all true, but they are not easy to prove right away. What we will show here is that:

THEOREM 9.10. *Any compact m -dimensional manifold X satisfies $\dim(X) \leq m$.*

This will be enough to apply the previous corollary and deduce Theorem 9.1 from the beginning of this chapter. The rest of this section is devoted to the proof of this theorem. First, we have the following metric characterization of dimension:

LEMMA 9.11. *Let (X, d) be a compact metric space and m an integer. Then $\dim(X) \leq m$ if and only if, for each $\delta > 0$, there exists an open cover \mathcal{V} with $\text{diam}(\mathcal{V}) < \delta$ and $\text{mult}(\mathcal{V}) \leq m + 1$.*

PROOF. For the direct implication, start with the cover by balls of radius $\delta/2$ and choose any refinement \mathcal{V} as in Definition 9.8. For the converse, let \mathcal{U} be an arbitrary open cover. It then suffices to consider an open cover as in the statement, with δ a Lebesgue number for the cover \mathcal{U} (see Proposition 6.10). \square

LEMMA 9.12. *Any compact subspace $K \subset \mathbb{R}^N$ has $\dim(K) \leq N$.*

PROOF. For simplicity in notations, we assume that $N = 2$. We will use the previous lemma. First, we consider the following families of opens in the plane:

- \mathcal{U}_0 consisting of the open unit squares with vertices in the integral points (m, n) ($m, n \in \mathbb{Z}$).
- \mathcal{U}_1 consisting of the open balls of radius $\frac{1}{2}$ with centers in the integral points.
- \mathcal{U}_2 consisting of the open balls of radius $\frac{1}{4}$ with centers in the middles of the edges of the integral lattice.

Make a picture! Note that the members of each of the families \mathcal{U}_i are disjoint. Hence

$$\mathcal{U} := \mathcal{U}_0 \cup \mathcal{U}_1 \cup \mathcal{U}_2$$

is an open cover of \mathbb{R}^2 of multiplicity 3 with $\text{diam}(\mathcal{U}) = \sqrt{2}$. To obtain similar covers of smaller diameter, we rescale. For each $\lambda > 0$, $\phi_\lambda : \mathbb{R}^2 \rightarrow \mathbb{R}^2$, $v \mapsto \lambda v$ is a homeomorphism. The rescaling of \mathcal{U} is

$$\mathcal{U}^\lambda = \{\phi_\lambda(U) : U \in \mathcal{U}\},$$

it has multiplicity 3 and diameter $\lambda\sqrt{2}$. Now, for $K \subset \mathbb{R}^2$ compact, we use the covers \mathcal{U}^λ (and the compactness of K) to apply the previous lemma. \square

LEMMA 9.13. *If X is a topological space and $X = \cup_{i=1}^p X_i$ where each X_i is closed in X with $\dim(X_i) \leq m$, then $\dim(X) \leq m$.*

PROOF. Proceeding inductively, we may assume $m = 2$, i.e. $X = Y \cup Z$ with Y, Z -closed in X of dimension $\leq m$. Let \mathcal{U} be an arbitrary open cover of X ; we prove that it has a refinement of multiplicity $\leq m + 1$. First we claim that \mathcal{U} has a refinement \mathcal{V} such that each $y \in Y$ lies in at most $m + 1$ members of \mathcal{V} . To see this, note that $\{U \cap Y : U \in \mathcal{U}\}$ is an open cover of Y , hence it has a refinement (covering Y) $\{Y_a : a \in A\}$ (for some indexing set A). For each $a \in A$, write $Y_a = Y \cap V_a$ with $V_a \subset X$ open, and choose $U_a \in \mathcal{U}$ such that $Y_a \subset U_a$. Then

$$\mathcal{V} := \{V_a \cap U_a : a \in A\} \cup \{U - Y : U \in \mathcal{U}\}$$

is the desired refinement. Re-index it as $\mathcal{V} = \{V_i : i \in I\}$ (we assume that there are no repetitions, i.e. $V_i \neq V_{i'}$ whenever $i \neq i'$). Similarly, let $\mathcal{W} = \{W_j : j \in J\}$ be a refinement of \mathcal{V} with the property that each $z \in Z$ belongs to at most $m + 1$ members of \mathcal{W} . For each $j \in J$, choose $\alpha(j) \in I$ such that $W_j \subset V_{\alpha(j)}$. For each $i \in I$, define

$$D_i = \cup_{j \in \alpha^{-1}(i)} W_j.$$

Consider $\mathcal{D} = \{D_i : i \in I\}$. Since for each $j \in J$, $i \in I$

$$W_j \subset D_{\alpha(j)}, \quad D_i \subset V_i,$$

\mathcal{D} is an open cover of X , which refines \mathcal{V} (hence also \mathcal{U}). It suffices to show that $\text{mult}(\mathcal{D}) \leq m + 1$. Assume that there exist k distinct indices i_1, \dots, i_k with

$$x \in D_{i_1}, \dots, D_{i_k}.$$

We have to show that $k \leq m + 1$. If $x \in Y$, since $D_i \subset V_i$ for all i , the defining property of \mathcal{V} implies that $k \leq m + 1$. On the other hand, for each $a \in \{1, \dots, k\}$, since $x \in D_{i_a}$, we find $j_a \in \alpha^{-1}(i_a)$ such that $x \in W_{j_a}$; hence, if $x \in Z$, then the defining property of \mathcal{W} implies that $k \leq m + 1$. \square

PROOF. (end of the proof of Theorem 9.10) Since X is a manifold, around each $x \in X$ we find a homeomorphism $\phi_x : U_x \rightarrow \mathbb{R}^n$ defined on an open neighborhood U_x of x . Let $V_x \subset U_x$ corresponding (by ϕ_x) to the open ball of radius 1. From the open cover $\{V_x : x \in X\}$, extract an open subcover, corresponding to $x_1, \dots, x_k \in X$. Then $X = \cup_i X_i$, and each X_i is a closed subset of X homeomorphic to a closed ball of radius 1, hence has $\dim(X_i) \leq m$. \square